



TABLE OF CONTENTS

Unit Features & Benefits	3-9
Model Number Identification	10
Options	11-12
Selection Procedure	13
General Data	14
General Data Notes	15
Heating Performance Data	16
Gross Systems Performance Data	17-20
Airflow Performance Data	21-36
Electrical Data.....	37-44
Dimensional Data	45-47
Field-Installed Accessories	48-49
Guide Specifications	50-57
Limited Warranty	58



RGEG STANDARD FEATURES INCLUDE:

- Factory charged with R-410A HFC refrigerant
- Wired and run tested
- Scroll compressors with internal line break overload and high pressure protection
- All models have two compressor stages
- Field convertible airflow – vertical downflow or horizontal sideflow
- Forkable base rails for easy handling and lifting
- Cooling operation up to 125°F ambient
- Two-stage gas heat input with direct spark ignition system, solid state furnace controls, and optimized induced draft combustion
- MicroChannel evaporator and condenser coil
- PlusOne® ServiceSmart package includes:
 - Slide-Out Filter Rack™
 - Qwik-Slide Blower Assembly™
 - Qwik-Clean Drain Pan™
- Overflow condensate sensor
- PlusOne® Diagnostics with Dual 7-Segment LED Display to meet code compliance
- Base pan with drawn supply and return opening
- ¼ turn fasteners on filter access door (on hinged models only)
- Color-coded and labeled wiring
- TXV refrigerant metering system
- Solid-core liquid line filter drier
- High pressure and low pressure/loss of charge protection with built-in Smart Logic
- Insulation encapsulated throughout entire unit
- High performance belt drive motor with variable pitch pulleys and quick adjust belt system
- Variable Frequency Drive (VFD) blower is standard
- Flexible footprint to support a variety of roof curbs
- MERV 8 and MERV 13 available as options

FACTORY INSTALLED OPTIONS:

- Economizer w/Single Enthalpy (Downflow/Vertical)
- Economizer w/Single Enthalpy (Downflow/Vertical) DDC
- Low Ambient Control Kit
- Freeze Stat Kit

- Return Smoke Detector (Downflow/Vertical)
- Return Smoke Detector (Horizontal)
- Return/Supply Smoke Detector (Downflow/Vertical)
- Return/Supply Smoke Detector (Horizontal)

FIELD INSTALLED ACCESSORIES:

Accessory	Model Number	Factory Installation Available?
Economizer w/Single Enthalpy (Downflow/Vertical)	RXRD-01MGDAM3	Yes
Economizer w/Single Enthalpy (Horizontal)	RXRD-01MGHAM3	No
Economizer w/Single Enthalpy (Downflow/Vertical) DDC	RXRD-01MGDBM3	Yes
Economizer w/Single Enthalpy (Horizontal) DDC	RXRD-01MGHBM3	No
Dual Enthalpy Kit	RXXR-BV01	No
Dual Enthalpy Kit DDC	RXXR-BV02	No
Power Exhaust (230V)	RXXR-CGF01C	No
Power Exhaust (460V)	RXXR-CGF01D	No
Power Exhaust (575V)	RXXR-CGF01Y	No
Manual Fresh Air Damper	RXRF-AGA1	No
Motorized Fresh Air Damper	RXRF-AGB1	No
Motorized Fresh Air Damper DDC	RXRF-AGC1	No
Roofcurb, 14	RXXR-DGC14	No
Roofcurb, 18	RXXR-DGC18	No
Roofcurb, 24	RXXR-DGC24	No
Roofcurb - Restraint Clips	RXXR-DGCRC	No
Roofcurb Adapter	RXXR-DCGCAE	No
Roofcurb Adapter Z-Bracket	RXXR-DGCAZ	No
Concentric Flush Mount Diffuser (15 & 17.5 ton)	RXRN-AEF2042	No
Concentric Flush Mount Diffuser (20 ton)	RXRN-AEF2348	No
Concentric Flush Mount Diffuser (25 ton)	RXRN-AEF2852	No
Concentric Step Down Diffuser (15 & 17.5 ton)	RXRN-AED2042	No
Concentric Step Down Diffuser (20 ton)	RXRN-AED2348	No

Accessory	Model Number	Factory Installation Available?
Concentric Step Down Diffuser (25 ton)	RXRN-AED2852	No
Concentric Adapter/Transition (15 & 17.5 ton)	RXMC-GG01	No
Concentric Adapter/Transition (20 ton)	RXMC-GG02	No
Concentric Adapter/Transition (25 ton)	RXMC-GG03	No
Flue Diverter Kit	RXXR-DGG05	No
Outdoor Coil Louver Kit	RXXR-LKG01	No
Non-Powered Convenience Outlet	RXXR-BN01	No
Comfort Alert (3 phase) Non-DDC	RXXR-AZG1	No
Comfort Alert (3 Phase) DDC	RXXR-AZG2	No
Carbon Dioxide Sensor (Wall Mount)	RXXR-AR02	No
BACnet Communicator Card	RXXR-AY01	No
LonWorks Communication Card	RXXR-AY02	No
Low-Ambient Control Kit	RXRZ-A05	Yes
Freeze Stat Kit	RXXR-AM06	Yes
Return Smoke Detector (Downflow/Vertical)	RXXR-BSG1	Yes
Return Smoke Detector (Horizontal)	RXXR-BSG2	Yes
Return/Supply Smoke Detector (Downflow/Vertical)	RXXR-BSG3	Yes
Return/Supply Smoke Detector (Horizontal)	RXXR-BSG4	Yes
MERV 8 Filter	RXMF-M08A22420	No
MERV 13 Filter	RXMF-M13A22420	No
Unfused Service Disconnect	RXXR-BPG1	Yes

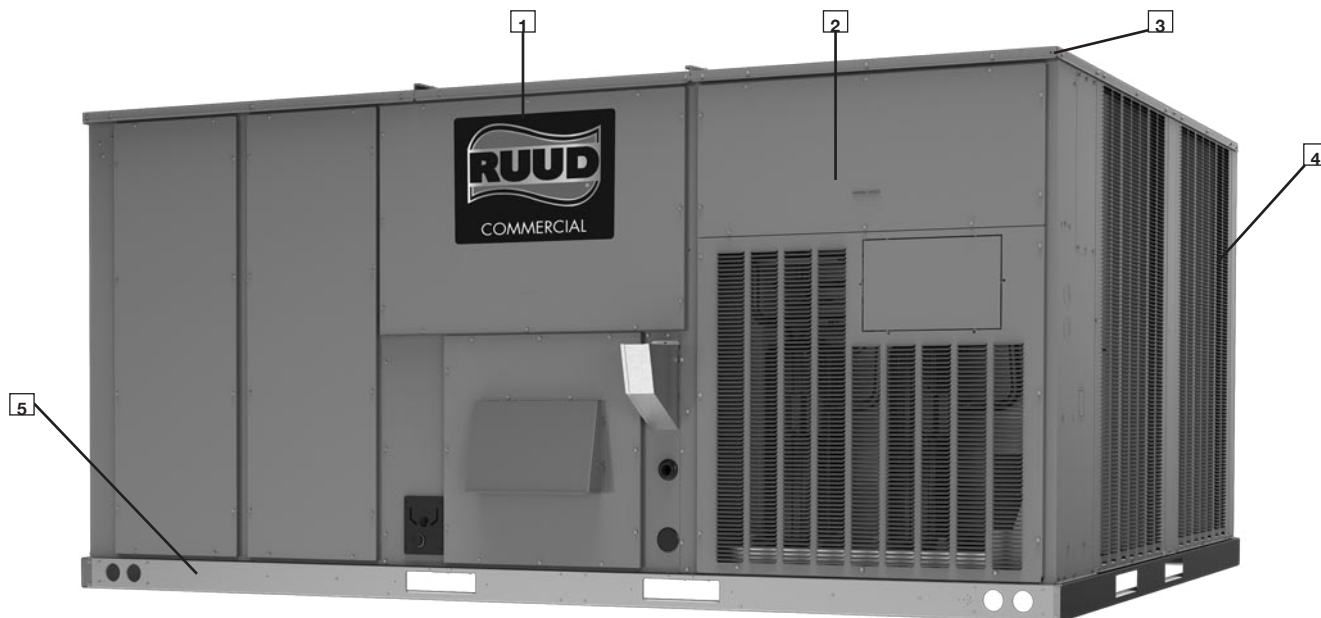

Cabinet and Foundation

Outwardly, the large Ruud Renaissance label (1) identifies the brand to the customer. The sheet-metal cabinet (2) uses 18-gauge material for structural components with an underlying coat of G90. To ensure the leak-proof integrity of these units, the design utilizes a top with a 1/8" drip lip (3) as well as gasket-protected panels and screws. The Ruud hail guard (optional) (4) sets the standard for coil protection in the industry. Electro deposition, baked-on enamel that is tested to withstand a rigorous 1000-hour salt spray test, per ASTM B117.

Anything built to last must start with the right foundation. Following that model, the foundation is comprised of 14-gauge, commercial-grade, full perimeter base rails (5) that integrate fork slots and rigging holes to save set-up time on the job site.

Easy Installation

The Renaissance line features a new footprint that simplifies the replacement process by eliminating the need for a new curb adapter and being able to match inlet, outlet and electrical connections of the most common/industry-standard configurations.

Base Pan

The base pan is stamped to form a 7/8" flange around the supply and return cover, which eliminates the worry of water entering the conditioned space (6). All insulation is secured with both adhesive and mechanical fasteners, and all edges are hidden.



Drain Pan

The Qwik-Clean Drain Pan™ (7) is made from a composite material that resists the growth of harmful bacteria. With both side and center drain options, the drain pan slides out completely for easy cleaning. It also features overflow detection as a standard feature.

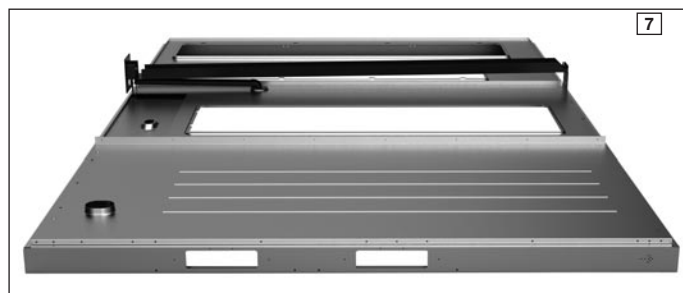

Test Standards

During development, each unit was tested to U.L. 1995, AHRI 340-360 as well as other Ruud-required reliability tests. Ruud adheres to stringent ISO 9002 quality procedures, and each unit bears the U.L. and AHRI certification labels located on the unit nameplate. Contractors can be assured that when a Ruud packaged unit arrives at the job, it is ready to go with a factory charge and quality checks. Each unit also proudly displays the "Made in the USA" designation.

Easy Access

All major compartments are easily accessible from the front of the unit: the electrical compartment, blower compartment, heating section, and outdoor section. Each compartment has mechanical fasteners. The filter compartment is accessed through a large, mechanically fastened panel. Information is readily available on the outside of the panel, with a nameplate that contains the model and serial numbers, electrical data, and other important unit information. Hinged access is available as an option for the electrical, blower, compressor and filter compartments.

Charging Charts, Wiring Diagrams, & Labels

The unit charging chart and rating plate are located on the top right corner of the economizer side of the unit. Electrical wiring diagrams are found on the control box cover, which allows contractors to move them to more readable locations. Having this information means easier model identification for the life of the product. Each unit also includes a production line quality test assurance label.



Filter Rack

Located within the filter compartment, the Slide-Out Filter Rack™ (9) allows easy change of eight 20" x 24" x 2" standard size filters.



Blower Assembly

Removal of the blower access panel provides full access to the blower compartment. Inside, the Qwik-Slide Blower Assembly™ (10) allows for easy removal of the blower as an assembly. This makes servicing the blower components such as VFD, motor, and adjusting the pulley much easier. The entire assembly slides out by removing four 5/16" screws from the blower retention bracket. This compartment also includes the low ambient control (11). The low ambient control allows the compressor to operate down to 0 degrees ambient temperature by cycling the outdoor fans on high pressure. The adjustable motor pulley (12) can easily be adjusted by loosening the bolts on either side of the motor mount. Removing the bolts allows for easy removal of the blower pulley by pushing the blower assembly up to loosen the belt. Once the pulley is removed, the motor sheave can be adjusted to the desired number of turns, ranging from 1 to 6 turns open.

Where the demands for the job require high static, Ruud offers drives that deliver nominal airflow up to 2" of static. By referring to the airflow performance tables listed in the installation instructions, proper static pressure and CFM requirements can be dialed in. The scroll housing (13) and blower scroll provide quiet and efficient airflow. The blower sheave is secured by an "H" bushing that firmly secures the pulley to the blower shaft, resulting in years of trouble-free operation. The "H" bushing allows for easy removal of the blower pulley from the shaft. This is an improvement from a set screw, which can score the shaft and create burrs that make blower-pulley removal difficult.

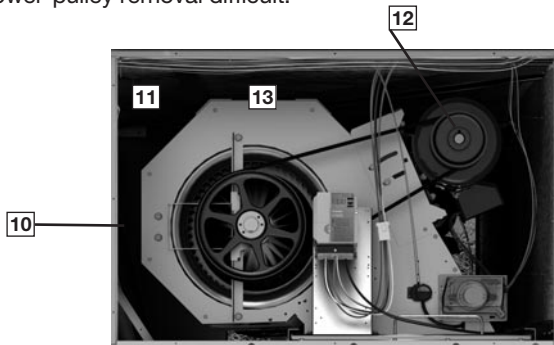

High and Low Pressure Switches & Freeze Stat

High pressure (14) and low pressure (15) switches are standard. They are located in the outdoor section. The optional Freeze Stat (16) is clipped onto the suction line in the blower compartment. The high-pressure switch shuts off the compressors if pressures exceeding 650 PSIG are detected. The low-pressure switch shuts off the compressors if a low pressure of 50 PSIG is detected due to loss of charge. Built-in Smart Logic reduces nuisance calls by only shutting off compressors after the third detection. The freeze stat protects the compressor if the evaporator coil gets too cold (below freezing) due to low airflow.

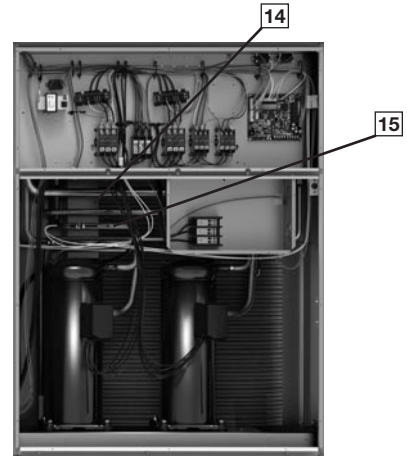

MicroChannel Evaporator & TXV

The patent-pending dual circuit evaporator coil (17) uses microchannel technology for maximum heat transfer, light weight, fewer manually brazed connections and reduced refrigerant charge. The TXV metering devices maintains superheat over a wide range of varying temperatures optimizing unit performance for all conditions.

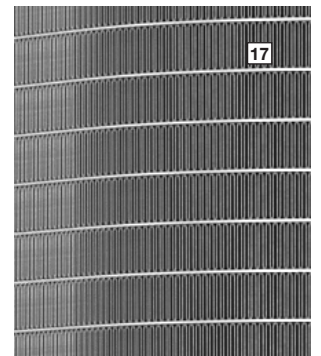

Control Box

Inside the control box (18), each electrical component is clearly labeled; that label matches the component to the wire diagram for ease of trouble shooting. Some wiring is numbered on each end of the termination and is color-coded to match the wiring diagram. The integrated furnace control, incorporates the PlusOne® Diagnostics: Dual 7-Segment LED Display with easy-to-understand fault codes. The control transformer has a low voltage circuit breaker that trips if an electrical short occurs. There is a compressor contactor for each compressor.

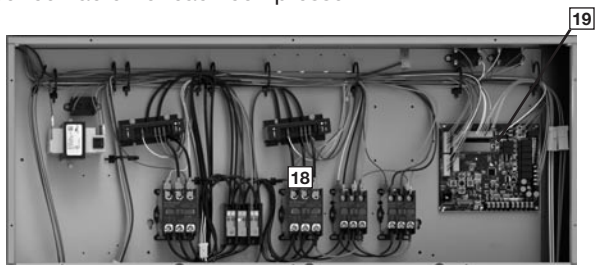

ClearControl™

The optional ClearControl™ system (19) consisting of a rooftop unit controller, temperature sensors, and pressure sensors, allows real-time monitoring and communication between rooftop units. The Rooftop Unit Controller (RTU-C) that is factory mounted and wired into the control panel. The RTU-C is a solid-state, micro-processor-based control board that provides flexible control and extensive diagnostics for all unit functions. The RTU-C, using proportional/integral control algorithms, performs specific unit functions that govern unit operation in response to zone conditions, system temperatures, system pressures, ambient conditions, and electrical inputs. The RTU-C features a 16 x 2 character LCD display and a five-button keypad for local configuration and direct diagnosis of the system (20). Features include a clogged filter switch (CFS), fan proving switch (FPS), return air temperature sensor (RAT), discharge air temperature sensor (DAT), and outdoor air temperature sensor (OAT). Freeze sensors (FS) are used in place of freeze stats to allow measurement of refrigerant suction line temperatures.

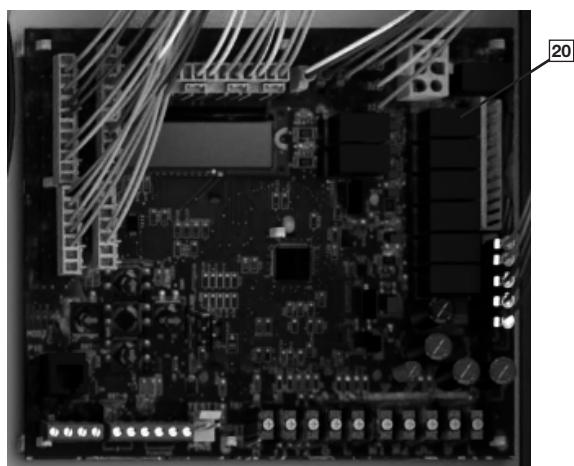

The unit Gas Electric with the RTU-C is specifically designed to be applied in four distinct applications:

30. **BACnet Communication** — The unit is compatible with a third party building management system that supports the BACnet Application Specific Controller device profile, with the use of a field installed BACnet Communication Module. The BACnet Communication Module plugs onto the unit RTU-C controller and allows communication between the RTU-C and the BACnet MSTP network. A zone sensor, a BACnet network zone sensor, a BACnet thermostat, or DDC controller may be used to send the zone temperature or thermostat demands to the RTU-C. The BACnet Communication Module is compatible with MSTP EIA-485 daisy chain networks communicating at 38.4 bps. It is compatible with twisted pair, shielded cables.
40. **LonWorks Communication** — The unit is compatible with a third party building management system that supports the LonMark Space Comfort Controller (SCC) functional profile or LonMark Discharge Air Controller (DAC) functional profile. This is accomplished with a field installed LonMark communication module. The LonMark Communication Module plugs onto the RTU-C controller and allows communication between the RTU-C and a LonWorks network. A zone sensor, a LonTalk network zone sensor, or a LonTalk thermostat or DDC controller may be used to send the zone temperature or thermostat demands to the RTU-C. The LonMark Communication Module utilizes an FTT-10A free topology transceiver communicating at 78.8 kbps. It is compatible with Echelon qualified, twisted pair cable, Belden 8471, or NEMA Level 4 cables. The module can communicate up to 1640 feet with no repeater. The LonWorks limit of 64 nodes per segment applies to this device.
50. **24V Thermostat Compatibility** — The unit is compatible with a programmable 24 volt thermostat. Connections are made via conventional thermostat screw terminals. Extensive unit status and diagnostics are displayed on the LCD screen of the RTU-C.
60. **Zone Sensor Compatibility** — The unit is compatible with a zone sensor and a mechanical or solid state time clock connected to the RTU-C. Extensive unit status and diagnostics are displayed on the LCD screen of the RTU-C.

ComfortAlert®

A factory or field installed Comfort Alert® (21) module is available for power phase-monitoring protection and additional compressor diagnostics. The alarms can be displayed on the RTU-C display or through the (BAS) network.

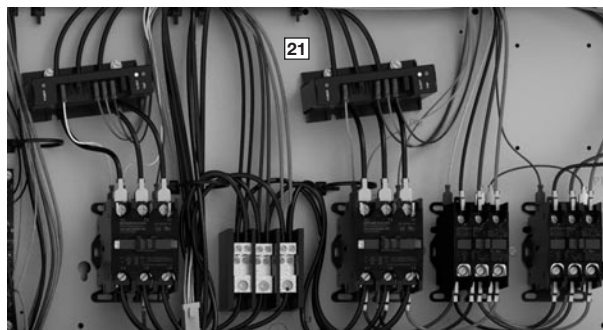

Variable Frequency Drive

The supply fan Variable Frequency Drive (VFD) (22) optimizes energy usage year round by providing a lower speed for first stage cooling operation, improving IEER's over the conventional constant fan system. Operating in the constant fan mode at the reduced speed can use as little as 1/5 of the energy of a conventional constant fan system. Also, by operating at a lower speed on first stage cooling, up to 126% more moisture is removed, improving comfort during low load operation. VFD comes standard in every model. The VFD supply fan factory option meets California Title 24 and ASHRAE 90.1-2016 requirements for multi blower speed control. VFD also ramps up to the desired speed, reducing stress on the supply fan components and noise from a sudden inrush of air. Because the airflow is cut in half during first stage cooling and constant fan operation, noise is much less during these modes of operation.



Convenience Outlet, Disconnect, & Circuit Breaker

For added convenience in the field, factory-installed options of powered and non-powered convenience outlet (23), disconnect (24) and circuit breakers are available. Low and high voltage can enter from the side or through the base. For ease of access, the U.L.-required low voltage barrier can be temporarily removed for low-voltage termination and then reinstalled.

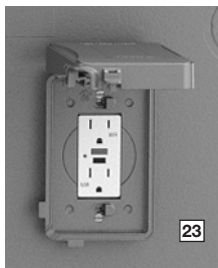

Easily Accessible Gauge Ports

To the right left of the compressor compartment are the easily accessible gauge ports. They are identified by labeling that identifies the compressor circuit, high pressure connection, (25) and low pressure connection (26). Because the gauge ports are mounted externally, an accurate diagnostic of system operation can be performed without removing access panels. Brass caps on the Schrader fitting ensure the gauge parts are leak proof.

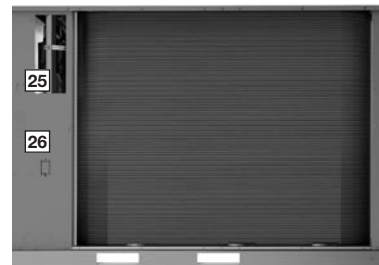

Furnace & Velocifin™ Gas Heat Exchanger

The furnace compartment contains the latest technology on the market. Each furnace is equipped with a two-stage gas valve (27) to provide two stages of gas heat input. The first stage operates at 70% of the second stage (full fire), 81% steady state efficiency is maintained. Stainless steel heat exchangers can be factory installed for those applications that have high fresh-air requirements or in applications with corrosive environments. The direct spark igniter (28) ensures reliable ignition in the most adverse conditions. This is coupled with remote flame sensor (29) so the flame is carried across the entire length of the burner assembly. Gas supply can be routed from the side or up through the base. Each furnace has the following safety devices to ensure consistent and reliable operation after ignition:

- Stainless steel heat exchanger warranty increases from 10 years to 20 years.
- Pressures switches to ensure adequate combustion airflow before ignition.
- Rollout switches to prevent obstruction or cracks in the heat exchanger.
- A limit device to protect the furnace from over-temperature problems.

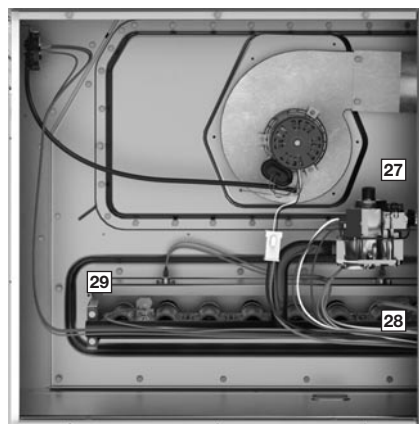

Compressor

The compressor compartment houses the heartbeat of the unit. The scroll compressor (30) is known for its long life and for reliable, quiet, and efficient operation. Each compressor has 4 rubber grommets (31) on the bottom for sound and vibration dampening. These units have two stages of efficient cooling operation in which the first stage is approximately 50% of second stage. Each unit comes standard with a filter dryer.

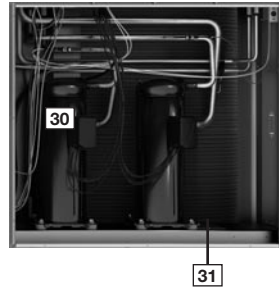

Condenser Fans

The condenser fan motors (32) can easily be accessed and maintained through the top of the unit. The 15 ton unit has down-mount fans which provide corrosion protection and easy removal. The 17.5, 20, and 25 ton models are designed with up-mounted fans. The polarized plug connection allows the motor to be changed quickly and eliminates the need to snake wires through the unit.

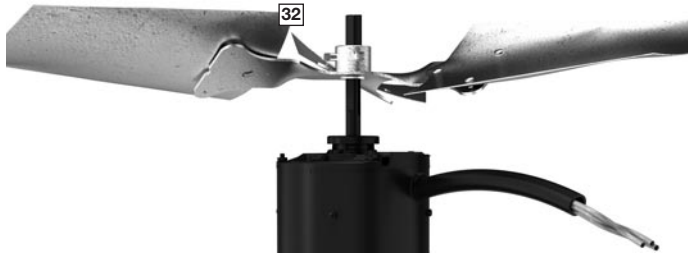

MicroChannel Condenser Technology

The outdoor coil uses the latest microchannel technology (33) for the most effective method of heat transfer. The outdoor coil is protected by optional louvered panels, which allow unobstructed airflow while protecting the unit from both the environment and vandalism.

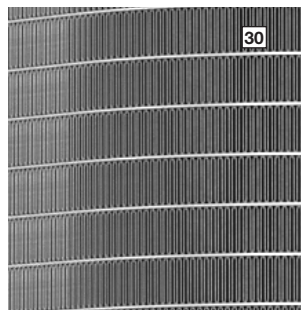

Coil Coating

Every unit offers the option of factory-applied ElectroFin® E-Coat condenser coating (34) that delivers superior corrosion resistance for outdoor coils to operate in the harshest of environments.



Economizer and Dampers

Each unit is designed for both down flow or horizontal applications for job configuration flexibility. The return air compartment can also contain an economizer (35). Each unit is pre-wired for the economizer to allow quick, plug-in installation. Available as a factory-installed option, the economizer provides free cooling when outdoor conditions are suitable and also provides fresh air to meet local requirements. It comes standard with single enthalpy controls, which can be upgraded to dual enthalpy easily in the field. The direct drive actuator combined with gear drive dampers has eliminated the need for linkage adjustment in the field. The economizer control has a minimum position set point, an outdoor-air set point, a mixed-air set point, a CO₂ set point. Barometric relief is standard on all economizers.



Power Exhaust is easily field-installed. The power exhaust is housed in the barometric relief opening and is easily slipped in with a plugin assembly. The wire harness to the economizer also has accommodations for a smoke detector.

The damper minimum position, actual damper position, power exhaust on/off set point, mixed air temperature limit set point, and Demand Controlled Ventilation (DCV) set point can be read and adjusted at the unit controller display or remotely through a network connection. The Space CO₂ level, mixed air temperature, and Economizer Status (free cooling available, single or dual enthalpy) can be read at the unit controller display or remotely through a network connection. Economizer faults will trigger a network alarm and can be read at the unit controller display or remotely through a network connection.

Roofcurb

The Ruud roofcurb is made for tool-less assembly at the jobsite by engaging tabs in slots of adjacent curb sides, which makes the assembly process quick and easy.

R **GE** **G** **2** **T** **180** **A** **C** **F** **32** **2** **B** **A** ********
1 **23** **4** **5** **6** **789** **10** **11** **12** **13 14** **15** **16** **17** **18 19 20 21**

1—Brand

R = Ruud

2, 3—Unit Type

GE = Packaged Gas/Electric

4—Cabinet Type

G = Large Commercial

5—Cooling Stages

2 = 2 stages of cooling

6—Efficiency Tier

T = Standard Efficiency

7, 8, 9—Capacity

180 = 15 ton

210 = 17.5 ton

240 = 20 ton

300 = 25 ton

10—Major series

A = 410A

11—Voltage

C = 3 phase 208-230/60

D = 3 phase 460/60

Y = 3 phase 575/60

12—Drive

F = Belt Drive - VFD Low

G = Belt Drive - VFD Medium

H = Belt Drive - VFD High

13, 14—Heat Capacity

32 = 320 MBH

40 = 400 MBH

15—Heat Configuration

2 = 2 Stage

B = 2 Stage Stainless

16—Control

B = Core Command &
Phase Monitor

C = Clear Control &
Phase Monitor

D = Clear Control & Comfort Alert

17—Minor series

A = 1st design

18, 19, 20, 21—Option Code

AA0A

FACTORY INSTALLED OPTION CODES FOR RGEG (15 TO 25 TON)

18				19				20			21	
LV = Louver protection				DC = Disconnect				EC = Economizer			M8 = MERV 8 Filter	
HA = Hinged Access				PC = Powered Convenience Outlet				SS = Supply & Return Smoke			M13 = MERV 13 Filter	
CC = Codenser Coil Coating												
				NP = Non-Powered Convenience Outlet				RS = Return Smoke				
				LF = Low Ambient & Freeze Stat								
				CB = Circuit Breaker								
OPTION CODE CHARACTER HIGHLIGHTED												
Opt.				Opt.				Opt.			Opt.	
A	None			A	None			0	None		A	Standard
B	LV			B	LF			1	EC		D	M8
C	HA			C	NP			2	RS		G	M13
D	LV	HA		D	LF	NP		3	EC	RS		
E	LV	CC		E	DC			4	SS			
F	LV	HA	CC	F	LF	DC		5	EC	SS		
				G	PC	DC						
				H	NP	DC						
				J	LF	PC	DC					
				K	LF	NP	DC					
				L	CB							
				M	LF	CB						
				N	PC	CB						
				P	NP	CB						
				Q	LF	PC	CB					
				R	LF	NP	CB					

Instructions for Factory Installed Option(s) Selection

Note: Three characters following the model number will be utilized to designate a factory-installed option or combination of options. If no factory option(s) is required, "AA0A" follows the model number.

- **Step 1:** In the table above, based on the desired features, choose option code character from highlighted options on the left side under the number 18. For example, the option code character "E" has Louver protection and Coil Coating.
- **Step 2:** In the table above, based on the desired features, choose option code character from highlighted options on the left side under the number 19. For example, the option code character "D" has Low Ambient/Freeze Stat and Non-powered convenience outlet.
- **Step 3:** In the table above, based on the desired features, choose option code character from highlighted options on the left side under the number 20. For example, the option code character "3" has Economizer and Return Smoke.
- The resulting option code from examples above is: "ED3D"
- **Step 4:** In the table above, based on the desired features, choose option code from highlighted options on the left side under the number 21. For example, the option code character "D" has MERV 8 filters.
- **Step 5:** Add your option code selection to the end of model number

○ Example: RGEG2T180ACCF000BA ED3D = RGEG2T180ACF000BAED3D

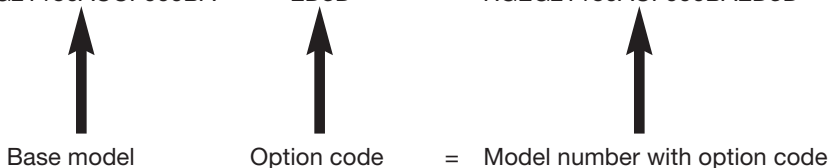

To select an RGEG Cooling and Heating unit to meet a job requirement, follow this procedure, with example, using data supplied in this specification sheet.

1. DETERMINE COOLING AND HEATING REQUIREMENTS AND SPECIFIC OPERATING CONDITIONS FROM PLANS AND SPECS.

Example:

Voltage—	208/240V – 3 Phase - 60 Hz
Total cooling capacity—	175,000 BTUH [51.2 kW]
Sensible cooling capacity—	140,000 BTUH [41.0 kW]
Heating capacity—	175,000 BTUH [51.2 kW]
*Condenser Entering Air—	95°F [35°C] DB
*Evaporator Mixed Air Entering—	65°F [18°C] WB; 78°F [26°C] DB
*Indoor Air Flow (vertical)—	6400 CFM [3020 L/s]
*External Static Pressure—	.70 in. WG

2. SELECT UNIT TO MEET COOLING REQUIREMENTS.

Since total cooling is within the range of a nominal 15 ton [35.2 kW] unit, enter cooling performance table at 95°F [35°C] DB condenser inlet air. Interpolate between 63°F [2°C] and 67°F [19°C] to determine total and sensible capacity and power input for 65°F [18°C] WB evap inlet air at 3750 CFM [1770 L/s] indoor air flow (table basis):

Total Capacity = 176,770 BTUH [51.8 kW]
Sensible Capacity = 138,000 BTUH [40.4 kW]
Power Input (Compressor and Cond. Fans) = 14,470 watts

Use formula [1.10 x CFM x (1 – DR) x (dbE – 80)] in note ① to determine sensible capacity at 80°F [26.7°C] DB evaporator entering air:

Sensible Capacity = 125,117 BTUH [36.7 kW]

3. CORRECT CAPACITIES OF STEP 2 FOR ACTUAL AIR FLOW.

Select factors from airflow correction table at 3700 & 3800 CFM, average data [1746.2 & 1793.4 L/s] and apply to data obtained in step 2 to obtain gross capacity:

Total Capacity, 176,770 x 1.02 = 180,309 BTUH [52.8 kW]
Sensible Capacity, 138,000 x 1.05 = 144,900 BTUH [42.5 kW]
Power Input 14,470 x 1.01 = 14,610 Watts

These are Gross Capacities, not corrected for blower motor heat or power.

4. DETERMINE BLOWER SPEED AND WATTS TO MEET SYSTEM DESIGN.

Enter Indoor Blower performance table at 6400 CFM, [3020 L/s]. Total ESP (external static pressure) per the spec of .60 in. WG [0.15kPa] includes the system duct and grilles. Add from the table “Component Air Resistance,” 0.05 in. WG [0.01 kPa] for wet coil, for a total selection static pressure of .65 (.7) in. WG [0.17 kPa], and use the Airflow Performance Downflow table to determine:

RPM = 794
BHP = 3.09 [2,304 Watts]
DRIVE = F (3 H.P. motor)

5. CALCULATE INDOOR BLOWER BTUH HEAT EFFECT FROM MOTOR WATTS, STEP 4.

$$\text{BTUH} = 2,304 \times 3.412 = 7,861$$

6. CALCULATE NET COOLING CAPACITIES, EQUAL TO GROSS CAPACITY, STEP 3, MINUS INDOOR BLOWER MOTOR HEAT.

$$\begin{aligned} \text{Net Total Capacity} &= 180,309 \text{ (step 3)} - 7,861 \text{ (step 5)} = \\ &172,448 \text{ BTUH [50.5 kW]} \\ \text{Net Sensible Capacity} &= 144,900 \text{ (step 3)} - 7,861 \text{ (step 5)} = \\ &137,039 \text{ BTUH [40.1 kW]} \end{aligned}$$

7. CALCULATE UNIT INPUT AND JOB EER.

$$\begin{aligned} \text{Total Power Input} &= 14,610 \text{ (step 3)} + 2,304 \\ &\text{(step 4)} = 16,914 \text{ Watts} \\ \text{EER} &= \frac{\text{Net Total BTUH [kW]} \text{ (step 6)}}{\text{Power Input, Watts (above)}} = \frac{172,448}{16,914} = 10.2 \end{aligned}$$

8. SELECT UNIT HEATING CAPACITY.

From Physical Data Table read that gas heating output (input rating x efficiency) is:

$$\text{Heating Capacity} = 320,000 \times 0.81 = 259,200 \text{ BTUH [76.0 kW]}$$

Choose Model RGEG2T180ACF322BAAA0A

*NOTE: These operating conditions are typical of a commercial application in a 95°F/79°F [35°C/26°C] design area with indoor design of 76°F [24°C] DB and 50% RH and 10% ventilation air, with the unit roof mounted and centered on the zone it conditions by ducts.

[] Designates Metric Conversions

NOM. SIZES 15-25 TONS [52.8-687.9 kW] ASHRAE 90.1-2019 COMPLIANT MODELS

Model RGE2T Series	180	210	240	300
Cooling Performance^A				
Gross Cooling Capacity Btu [kW]	178,000 [52.15]	208,000 [60.94]	236,000 [69.15]	296,000 [86.73]
EER	10.8	10.8	10.8	9.8
IEER ^B	14	14	14	13
Nominal CFM/AHRI Rated CFM [L/s]	6000/6100 [2831/2879]	7000/6900 [3303/3256]	8000/7300 [3775/3445]	10000/8400 [4719/3964]
AHRI Net Cooling Capacity Btu [kW]	172,000 [50.4]	200,000 [58.6]	228,000 [66.8]	285,000 [85.53]
Net Sensible Capacity Btu [kW]	115,570 [33.86]	133,970 [39.25]	152,760 [44.76]	189,950 [55.65]
Net Latent Capacity Btu [kW]	56,430 [16.53]	66,030 [19.35]	75,240 [22.05]	95,050 [27.86]
Net System Power kW	16.4	19.2	22	30.4
Heating Performance (Gas)^C				
Heating Input Btu [kW] (2nd Stage)	320,000 [93.76]	320,000 [93.76]	400,000 [117.2]	400,000 [117.2]
Heating Output Btu [kW] (2nd Stage)	259,200 [75.94]	259,200 [75.94]	323,000 [94.64]	323,000 [94.64]
Temperature Rise Range °F [°C] (2nd Stage)	25-55 [13.9-30.6]	25-55 [13.9-30.6]	25-55 [13.9-30.6]	25-55 [13.9-30.6]
Steady State Efficiency (%)	81	81	81	81
No. Burners	8	8	8	8
No. Stages	2	2	2	2
Gas Connection Pipe Size in. [mm]	1 [25.4]	1 [25.4]	1 [25.4]	1 [25.4]
Compressor				
No./Type	2/Scroll	2/Scroll	2/Scroll	2/Scroll
Outdoor Coil - Fin Type				
Tube Type	Louvered	Louvered	Louvered	Louvered
MicroChannel Depth in. [mm]	MicroChannel	MicroChannel	MicroChannel	MicroChannel
Face Area sq. ft. [sq. m]	1 [25.4]	1 [25.4]	1 [25.4]	1 [25.4]
Rows/FPI [FPcm]	36.3 [3.37]	46.2 [4.29]	46.2 [4.29]	46.2 [4.29]
Indoor Coil - Fin Type				
Tube Type	Louvered	Louvered	Louvered	Louvered
MicroChannel Depth in. [mm]	MicroChannel	MicroChannel	MicroChannel	MicroChannel
Face Area sq. ft. [sq. m]	1 [25.4]	1 [25.4]	1.25 [31.8]	1.25 [31.8]
Rows/FPI [FPcm]	23.8 [2.21]	23.8 [2.21]	23.8 [2.21]	23.8 [2.21]
Refrigerant Control	1/18 [7]	1/18 [7]	1/18 [7]	1/18 [7]
Drain Connection No./Size in. [mm]	TX Valves	TX Valves	TX Valves	TX Valves
Outdoor Fan - Type				
No. Used/Diameter in. [mm]	Propeller	Propeller	Propeller	Propeller
Drive Type/No. Speeds	2/24 [609.6]	2/30 [762]	2/30 [762]	2/30 [762]
CFM [L/s]	Direct/1	Direct/1	Direct/1	Direct/1
No. Motors/HP	12000 [5663]	14000 [6607]	16800 [7928]	19000 [8966]
Motor RPM	2 at 3/4 HP	2 at 1 1/2 HP	2 at 1 1/2 HP	2 at 1 1/2 HP
Indoor Fan - Type				
No. Used/Diameter in. [mm]	FC Centrifugal	FC Centrifugal	FC Centrifugal	FC Centrifugal
Drive Type	2/15x15 [381x381]	2/15x15 [381x381]	2/15x15 [381x381]	2/15x15 [381x381]
No. Speeds	Belt (Adjustable)	Belt (Adjustable)	Belt (Adjustable)	Belt (Adjustable)
No. Motors	Single	Single	Single	Single
Motor HPE	1	1	1	1
Filter - Type				
Furnished	Disposable	Disposable	Disposable	Disposable
(NO.) Size Recommended in. [mm x mm x mm]	Yes	Yes	Yes	Yes
Refrigerant Charge Oz. [g] Circuit 1/Circuit 2				
	(8)2x24x20 [51x610x508]	(8)2x24x20 [51x610x508]	(8)2x24x20 [51x610x508]	(8)2x24x20 [51x610x508]
Weights				
Net Weight lbs. [kg]	192/192 [5443/5443]	205/205 [5812/5812]	205/205 [5812/5812]	224/224 [6350/6350]
Ship Weight lbs. [kg]	2030 [921]	2100 [952]	2120 [962]	2190 [993]
Max. Ship Weight lbs. [kg]	2130 [966]	2180 [989]	2220 [1007]	2290 [1039]
Max Installed Weight lbs. [kg]	2800 [1270]	2870 [1301]	2890 [1310]	2960 [1342]
	2700 [1224]	2770 [1256]	2790 [1265]	2860 [1297]

See Page 15 for Notes.

[] Designates Metric Conversions

NOTES:

- A. Cooling Performance is rated at 95° F ambient, 80° F entering dry bulb, 67° F entering wet bulb. Gross capacity does not include the effect of fan motor heat. AHRI capacity is net and includes the effect of fan motor heat. Units are suitable for operation to $\pm 20\%$ of nominal cfm. Units are certified in accordance with the Unitary Air Conditioner Equipment certification program, which is based on AHRI Standard 340/360.
- B. EER and Integrated Energy Efficiency Ratio (IEER) are rated in accordance with AHRI Standard 340/360.
- C. Heating Performance limit settings and rating data were established and approved under laboratory test conditions using American National Institute Standards. Ratings shown are for elevation up to 2000 feet. For elevations above 2000 feet, ratings should be reduced at the rate of 4% for each 1000 feet above sea level. See the Gas Heat Performance tables for more unit information.
- D. See Airflow Performance tables for more horsepower and more Indoor Fan information.

RGEG** HEATING PERFORMANCE—208-230V & 575V

TONNAGE	15 TON	17.5 TON	20 TON	25 TON
Heating Input BTU[KW] (High-Fire/ Low-Fire)	320,000/224,000 [93.79/65.65]	320,000/224,000 [93.79/65.65]	400,000/280,000 [117.24/82.07]	400,000/280,000 [117.24/82.07]
Heating Output BTU[KW] (High-Fire/ Low-Fire)	259,200/181,400 [75.97/53.17]	259,200/181,400 [75.97/53.17]	324,000/226,800 [94.96/66.48]	324,000/226,800 [94.96/66.48]
High-Fire Rise Range °F [°C]	25-55 [14-31]	25-55 [14-31]	25-55 [14-31]	25-55 [14-31]
Low-Fire Rise Range °F [°C]	25-55 [14-31]	25-55 [14-31]	25-55 [14-31]	25-55 [14-31]
Main Limit Temp °F	135	135	140	140
Rollout Temp °F	300	300	350	350
Rating ESP In. W.C	0.33	0.33	0.33	0.33
Maximum ESP In. W.C	1	1.3	1	0.8
Max Outlet Air Temp °F [°C]	200 [93.33]	200 [93.33]	200 [93.33]	200 [93.33]
% AFUE	—	—	—	—
% Steady State Efficiency	81%	81%	81%	81%

TONNAGE	15 TON	17.5 TON	20 TON		25 TON	
Heating Input BTU[KW] (High-Fire/ Low-Fire)	320,000/224,000 [93.79/65.65]	320,000/224,000 [93.79/65.65]	400,000/280,000 [117.24/82.07]	320,000/224,000 [93.79/65.65]	400,000/280,000 [117.24/82.07]	320,000/224,000 [93.79/65.65]
Heating Output BTU[KW] (High-Fire/ Low-Fire)	259,200/181,400 [75.97/53.17]	259,200/181,400 [75.97/53.17]	324,000/226,800 [94.96/66.48]	259,200/181,400 [75.97/53.17]	324,000/226,800 [94.96/66.48]	259,200/181,400 [75.97/53.17]
High-Fire Rise Range °F [°C]	25-55 [14-31]	25-55 [14-31]	25-55 [14-31]	25-55 [14-31]	25-55 [14-31]	25-55 [14-31]
Low-Fire Rise Range °F [°C]	25-55 [14-31]	25-55 [14-31]	25-55 [14-31]	25-55 [14-31]	25-55 [14-31]	25-55 [14-31]
Main Limit Temp °F	135	135	140	135	140	135
Rollout Temp °F	300	300	350	300	350	300
Rating ESP In. W.C	0.33	0.33	0.33	0.33	0.33	0.33
Maximum ESP In. W.C	1	1.3	1		0.8	
Max Outlet Air Temp °F [°C]	200 [93.33]	200 [93.33]	200 [93.33]		200 [93.33]	
% AFUE	—	—	—		—	
% Steady State Efficiency	81%	81%	81%		81%	

COOLING PERFORMANCE DATA — RGE2T180A

w/E		ENTERING INDOOR AIR @ 80°F [26.7°C] dbE ①											
		71°F [21.7°C]		67°F [19.4°C]		63°F [17.2°C]		61°F [16.1°C]		59°F [15.0°C]		59°F [15.0°C]	
CFM [L/s]		7200 [3398]	5900 [2784]	4800 [2265]	7200 [3398]	5900 [2784]	4800 [2265]	7200 [3398]	5900 [2784]	4800 [2265]	7200 [3398]	5900 [2784]	4800 [2265]
DR ①		0.3	0.27	0.25	0.3	0.27	0.25	0.3	0.27	0.25	0.3	0.27	0.25
75 [23.9]	Total BTUH [kW]	207.4 [60.8]	199.4 [58.4]	192.7 [56.5]	196.0 [57.4]	188.4 [55.2]	182.0 [53.3]	186.4 [54.6]	179.3 [52.5]	173.2 [50.7]	182.4 [53.4]	175.4 [51.4]	169.4 [49.6]
	Sens BTUH [kW]	102.6 [30.1]	93.0 [27.3]	84.9 [24.9]	135.8 [39.8]	123.1 [36.1]	112.4 [32.9]	159.0 [46.6]	144.2 [42.3]	131.7 [38.6]	165.0 [48.4]	149.7 [43.9]	136.6 [40.0]
	Power	12.2	11.9	11.7	12.0	11.8	11.6	11.9	11.7	11.5	11.8	11.6	11.4
80 [26.7]	Total BTUH [kW]	205.3 [60.2]	197.4 [57.9]	190.7 [55.9]	193.9 [56.8]	186.4 [54.6]	180.1 [52.8]	184.3 [54.0]	177.2 [51.9]	171.2 [50.2]	180.3 [52.8]	173.4 [50.8]	167.5 [49.1]
	Sens BTUH [kW]	103.2 [30.3]	93.6 [27.4]	85.5 [25.0]	136.4 [40.0]	123.7 [36.3]	113.0 [33.1]	159.7 [46.8]	144.8 [42.4]	132.2 [38.7]	165.7 [48.6]	150.2 [44.0]	137.2 [40.2]
	Power	12.8	12.5	12.3	12.7	12.4	12.2	12.5	12.3	12.1	12.5	12.2	12.0
85 [29.4]	Total BTUH [kW]	202.9 [59.5]	195.1 [57.2]	188.5 [55.2]	191.5 [56.1]	184.1 [54.0]	177.9 [52.1]	182.0 [53.3]	175.0 [51.3]	169.0 [49.5]	177.9 [52.1]	171.1 [50.1]	165.3 [48.4]
	Sens BTUH [kW]	103.3 [30.3]	93.7 [27.4]	85.5 [25.1]	136.5 [40.0]	123.8 [36.3]	113.0 [33.1]	159.7 [46.8]	144.8 [42.4]	132.2 [38.7]	165.7 [48.6]	150.3 [44.0]	137.2 [40.2]
	Power	13.4	13.2	13.0	13.3	13.1	12.8	13.2	12.9	12.7	13.1	12.9	12.7
90 [32.2]	Total BTUH [kW]	200.3 [58.7]	192.5 [56.4]	186.0 [54.5]	188.8 [55.3]	181.5 [53.2]	175.4 [51.4]	179.3 [52.5]	172.4 [50.5]	166.5 [48.8]	175.2 [51.3]	168.5 [49.4]	162.8 [47.7]
	Sens BTUH [kW]	102.7 [30.1]	93.2 [27.3]	85.0 [24.9]	135.9 [39.8]	123.3 [36.1]	112.5 [33.0]	159.2 [46.6]	144.3 [42.3]	131.8 [38.6]	165.2 [48.4]	149.8 [43.9]	136.7 [40.1]
	Power	14.1	13.9	13.6	14.0	13.7	13.5	13.9	13.6	13.4	13.8	13.5	13.3
95 [35]	Total BTUH [kW]	197.3 [57.8]	189.7 [55.6]	183.2 [53.7]	185.8 [54.5]	178.7 [52.4]	172.6 [50.6]	176.3 [51.7]	169.5 [49.7]	163.7 [48.0]	172.2 [50.5]	165.6 [48.5]	160.0 [46.9]
	Sens BTUH [kW]	101.6 [29.8]	92.1 [27.0]	84.1 [24.6]	134.8 [39.5]	122.2 [35.8]	111.6 [32.7]	158.0 [46.3]	143.3 [42.0]	130.8 [38.3]	164.0 [48.1]	148.7 [43.6]	135.8 [39.8]
	Power	14.9	14.6	14.3	14.7	14.4	14.2	14.6	14.3	14.1	14.5	14.3	14.0
100 [37.8]	Total BTUH [kW]	194.0 [56.8]	186.5 [54.7]	180.2 [52.8]	182.5 [53.5]	175.5 [51.4]	169.5 [49.7]	173.0 [50.7]	166.3 [48.7]	160.7 [47.1]	168.9 [49.5]	162.4 [47.6]	156.9 [46.0]
	Sens BTUH [kW]	99.8 [29.3]	90.5 [26.5]	82.7 [24.2]	133.0 [39.0]	120.6 [35.4]	110.1 [32.3]	156.3 [45.8]	141.7 [41.5]	129.4 [37.9]	162.3 [47.6]	147.2 [43.1]	134.4 [39.4]
	Power	15.6	15.3	15.1	15.5	15.2	15.0	15.4	15.1	14.8	15.3	15.0	14.7
105 [40.6]	Total BTUH [kW]	190.4 [55.8]	183.0 [53.6]	176.8 [51.8]	178.9 [52.4]	172.0 [50.4]	166.2 [48.7]	169.4 [49.6]	162.9 [47.7]	157.3 [46.1]	165.3 [48.5]	159.0 [46.6]	153.6 [45.0]
	Sens BTUH [kW]	97.5 [28.6]	88.4 [25.9]	80.7 [23.7]	130.7 [38.3]	118.5 [34.7]	108.2 [31.7]	153.9 [45.1]	139.6 [40.9]	127.4 [37.3]	159.9 [46.9]	145.0 [42.5]	132.4 [38.8]
	Power	16.4	16.1	15.9	16.3	16.0	15.7	16.2	15.9	15.6	16.1	15.8	15.5
110 [43.3]	Total BTUH [kW]	186.5 [54.6]	179.3 [52.5]	173.2 [50.8]	175.0 [51.3]	168.3 [49.3]	162.6 [47.6]	165.5 [48.5]	159.1 [46.6]	153.7 [45.0]	161.4 [47.3]	155.2 [45.5]	150.0 [43.9]
	Sens BTUH [kW]	94.6 [27.7]	85.7 [25.1]	78.3 [22.9]	127.8 [37.4]	115.8 [33.9]	105.8 [31.0]	151.0 [44.2]	136.9 [40.1]	125.3 [36.6]	157.0 [46.0]	142.4 [41.7]	130.0 [38.1]
	Power	17.3	17.0	16.7	17.2	16.8	16.6	17.0	16.7	16.4	17.0	16.7	16.4
115 [46.1]	Total BTUH [kW]	182.3 [53.4]	175.3 [51.4]	169.3 [49.6]	170.8 [50.1]	164.3 [48.1]	158.7 [46.5]	161.3 [47.3]	155.1 [45.4]	149.8 [43.9]	157.3 [46.1]	151.2 [44.3]	146.1 [42.8]
	Sens BTUH [kW]	91.0 [26.7]	82.5 [24.2]	75.3 [22.1]	124.2 [36.4]	112.6 [33.0]	102.8 [30.1]	147.5 [43.2]	133.7 [39.2]	122.1 [35.8]	153.5 [45.0]	139.2 [40.8]	127.0 [37.2]
	Power	18.2	17.8	17.5	18.1	17.7	17.4	17.9	17.6	17.3	17.9	17.5	17.2
120 [48.9]	Total BTUH [kW]	177.8 [52.1]	171.0 [50.1]	165.2 [48.4]	166.3 [48.7]	159.9 [46.9]	154.5 [45.3]	156.8 [46.0]	150.8 [44.2]	145.7 [42.7]	152.8 [44.8]	146.9 [43.0]	141.9 [41.6]
	Sens BTUH [kW]	86.9 [25.5]	78.8 [23.1]	71.9 [21.1]	120.1 [35.2]	108.9 [31.9]	99.4 [29.1]	143.3 [42.0]	130.0 [38.1]	118.6 [34.8]	149.3 [43.8]	135.4 [39.7]	123.6 [36.2]
	Power	19.1	18.7	18.4	19.0	18.6	18.3	18.9	18.5	18.2	18.8	18.4	18.1
125 [51.7]	Total BTUH [kW]	173.0 [50.7]	166.3 [48.7]	160.7 [47.1]	161.6 [47.3]	155.3 [45.5]	150.1 [44.0]	152.0 [44.5]	146.2 [42.8]	141.2 [41.4]	148.0 [43.4]	142.3 [41.7]	137.4 [40.3]
	Sens BTUH [kW]	82.1 [24.1]	74.5 [21.8]	68.0 [19.9]	115.4 [33.8]	104.6 [30.7]	95.5 [28.0]	138.6 [40.6]	125.7 [36.8]	114.7 [33.6]	144.6 [42.4]	131.1 [38.4]	119.7 [35.1]
	Power	20.1	19.7	19.4	19.9	19.6	19.2	19.8	19.4	19.1	19.8	19.4	19.1

DR — Depression ratio
dbE — Entering air dry bulb
w/E — Entering air wet bulb

NOTES: ① When the entering air dry bulb is other than 80°F [27°C], adjust the sensible capacity from the table by adding [1.10 x CFM x (1 - DR) x (dbE - 80)].

[] Designates Metric Conversions

Total — Total capacity x 1000 BTUH
Sens — Sensible capacity x 1000 BTUH
Power — KW input

COOLING PERFORMANCE DATA — RGE2T210A

wBE		ENTERING INDOOR AIR @ 80°F [26.7°C] dbE ①													
		71°F [21.7°C]			67°F [19.4°C]			63°F [17.2°C]			61°F [16.1°C]			59°F [15.0°C]	
CFM [L/s]		8400 [3964]	5600 [2643]	8400 [3964]	5600 [2643]	8400 [3964]	5600 [2643]	8400 [3964]	5600 [2643]	8400 [3964]	5600 [2643]	8400 [3964]	5600 [2643]	8400 [3964]	5600 [2643]
DR ①		0.3	0.25	0.3	0.25	0.3	0.25	0.3	0.25	0.3	0.25	0.3	0.25	0.3	0.25
75 [23.9]	Total BTUH [kW]	238.6 [69.9]	229.5 [67.2]	227.1 [66.6]	218.5 [64.0]	217.6 [63.8]	209.3 [61.3]	202.1 [59.2]	198.4 [58.1]	213.5 [62.6]	205.4 [60.2]	198.4 [58.1]	195.4 [57.2]	210.0 [61.5]	202.0 [59.2]
	Sens BTUH [kW]	125.0 [36.6]	113.5 [33.3]	158.2 [46.3]	143.6 [42.1]	181.4 [53.1]	164.7 [48.3]	164.7 [48.3]	164.7 [48.3]	150.2 [44.0]	187.4 [54.9]	170.1 [49.8]	188.3 [55.2]	171.0 [50.1]	155.9 [45.7]
80 [26.7]	Power	14.4	14.1	14.3	14.0	14.2	13.9	13.9	13.7	14.1	13.8	14	13.8	14	13.5
	Total BTUH [kW]	236.5 [69.3]	227.5 [66.7]	225.0 [65.9]	216.5 [63.4]	215.5 [63.1]	207.3 [60.7]	200.2 [58.7]	196.4 [57.6]	196.4 [57.6]	211.4 [62.0]	203.4 [59.6]	207.9 [60.9]	200.0 [58.6]	193.1 [56.6]
80 [26.7]	Sens BTUH [kW]	125.6 [36.8]	114.1 [33.4]	158.8 [46.5]	144.2 [42.2]	182.0 [53.3]	165.2 [48.4]	165.2 [48.4]	150.7 [44.2]	188 [55.1]	170.7 [50.0]	189.0 [55.4]	171.5 [50.3]	156.5 [45.8]	156.5 [45.8]
	Power	15.0	14.7	14.9	14.6	14.8	14.5	14.5	14.3	14.7	14.4	14.6	14.4	14.1	14.1
85 [29.4]	Total BTUH [kW]	234.1 [68.6]	225.2 [66.0]	222.6 [65.2]	214.2 [62.8]	213.1 [62.4]	205.0 [60.1]	198.0 [58.0]	194.2 [56.9]	209.1 [61.3]	201.1 [58.9]	205.5 [60.2]	197.7 [57.9]	190.9 [55.9]	190.9 [55.9]
	Sens BTUH [kW]	125.7 [36.8]	114.1 [33.4]	158.8 [46.5]	144.2 [42.2]	182.0 [53.3]	165.3 [48.4]	165.3 [48.4]	150.7 [44.2]	188.1 [55.1]	170.7 [50.0]	189.0 [55.4]	171.6 [50.3]	156.5 [45.9]	156.5 [45.9]
85 [29.4]	Power	15.7	15.4	15.5	15.3	15.4	15.1	15.1	14.9	15.4	15.1	15.3	15.0	14.8	14.8
	Total BTUH [kW]	231.4 [67.8]	222.6 [65.2]	219.9 [64.5]	211.6 [62.0]	210.4 [61.7]	202.4 [59.3]	195.5 [57.3]	192.7 [56.5]	206.4 [60.5]	198.5 [58.2]	202.8 [59.4]	195.1 [57.2]	188.4 [55.2]	188.4 [55.2]
90 [32.2]	Sens BTUH [kW]	125.1 [36.7]	113.6 [33.3]	158.3 [46.4]	143.7 [42.1]	181.5 [53.2]	164.8 [48.3]	164.8 [48.3]	150.3 [44.0]	187.5 [54.9]	170.2 [49.9]	188.4 [55.2]	171.1 [50.1]	156.0 [45.7]	156.0 [45.7]
	Power	16.4	16.1	16.2	15.9	16.1	15.8	15.8	15.5	16.1	15.7	16.0	15.7	15.4	15.4
95 [35]	Total BTUH [kW]	228.4 [66.9]	219.7 [64.4]	217.0 [63.6]	208.7 [61.2]	207.4 [60.8]	199.5 [58.5]	192.7 [56.5]	189.6 [55.6]	203.4 [59.6]	195.6 [57.3]	199.8 [58.6]	192.2 [56.3]	185.6 [54.4]	185.6 [54.4]
	Sens BTUH [kW]	124.0 [36.3]	112.6 [33.0]	157.1 [46.1]	142.7 [41.8]	180.4 [52.8]	163.7 [48.0]	163.7 [48.0]	149.3 [43.8]	186.4 [54.6]	169.2 [49.6]	187.3 [54.9]	170.0 [49.8]	155.1 [45.4]	155.1 [45.4]
95 [35]	Power	17.1	16.8	17.0	16.6	16.8	16.5	16.5	16.3	16.8	16.5	16.7	16.4	16.1	16.1
	Total BTUH [kW]	225.1 [66.0]	216.5 [63.5]	213.7 [62.6]	205.5 [60.2]	204.1 [59.8]	196.4 [57.5]	189.6 [55.6]	186.3 [54.6]	200.1 [58.6]	192.5 [56.4]	196.5 [57.6]	189.0 [55.4]	182.6 [53.5]	182.6 [53.5]
100 [37.8]	Sens BTUH [kW]	122.2 [35.8]	111.0 [32.5]	155.4 [45.5]	141.1 [41.3]	178.6 [52.3]	162.2 [47.5]	162.2 [47.5]	147.9 [43.3]	184.6 [54.1]	167.6 [49.1]	185.6 [54.4]	168.5 [49.4]	153.7 [45.0]	153.7 [45.0]
	Power	17.9	17.5	17.7	17.4	17.6	17.3	17.3	17.0	17.6	17.2	17.5	17.2	16.9	16.9
105 [40.6]	Total BTUH [kW]	221.5 [64.9]	213.1 [62.4]	210.1 [61.6]	202.1 [59.2]	200.5 [58.8]	192.9 [56.5]	186.3 [54.6]	183.2 [53.5]	196.5 [57.6]	189.0 [55.4]	192.9 [56.5]	185.6 [54.4]	179.2 [52.5]	179.2 [52.5]
	Sens BTUH [kW]	119.9 [35.1]	108.9 [31.9]	153.1 [44.9]	139.0 [40.7]	176.3 [51.7]	160.0 [46.9]	160.0 [46.9]	146.0 [42.8]	182.3 [53.4]	165.5 [48.5]	183.2 [53.7]	166.3 [48.0]	151.7 [44.5]	151.7 [44.5]
105 [40.6]	Power	18.7	18.3	18.5	18.2	18.4	18.1	18.1	17.8	18.4	18	18.3	18.0	17.7	17.7
	Total BTUH [kW]	217.6 [63.8]	209.4 [61.3]	206.2 [60.4]	198.3 [58.1]	196.6 [57.6]	189.2 [55.4]	182.7 [53.5]	179.9 [52.4]	192.6 [56.4]	185.3 [54.3]	189.0 [55.4]	181.8 [53.3]	175.6 [51.5]	175.6 [51.5]
110 [43.3]	Sens BTUH [kW]	117.0 [34.3]	106.2 [31.1]	150.1 [44.0]	136.3 [39.9]	173.3 [50.8]	157.4 [46.1]	157.4 [46.1]	143.5 [42.1]	179.3 [52.6]	162.8 [47.7]	180.3 [52.8]	163.7 [48.0]	149.3 [43.7]	149.3 [43.7]
	Power	19.5	19.2	19.4	19	19.3	18.9	18.9	18.6	19.2	18.9	19.2	18.8	18.5	18.5
115 [46.1]	Total BTUH [kW]	213.4 [62.5]	205.3 [60.2]	202.0 [59.2]	194.3 [56.9]	192.5 [56.4]	185.1 [54.3]	178.8 [52.4]	175.0 [51.3]	188.4 [55.2]	181.2 [53.1]	184.8 [54.2]	177.8 [52.1]	171.7 [50.3]	171.7 [50.3]
	Sens BTUH [kW]	113.4 [33.2]	103.0 [30.2]	146.6 [43.0]	133.1 [39.0]	169.8 [49.8]	154.2 [45.2]	154.2 [45.2]	140.6 [41.2]	175.8 [51.5]	159.6 [46.8]	176.7 [51.8]	160.5 [47.0]	146.4 [42.9]	146.4 [42.9]
115 [46.1]	Power	20.4	20.0	20.3	19.9	20.2	19.8	19.8	19.5	20.1	19.7	20.0	19.7	19.3	19.3
	Total BTUH [kW]	208.9 [61.2]	201.0 [58.9]	197.5 [57.9]	190.0 [55.7]	188.0 [55.1]	180.8 [53.0]	174.6 [51.2]	170.9 [50.1]	183.9 [53.9]	176.9 [51.8]	180.4 [52.8]	173.5 [50.8]	167.6 [49.1]	167.6 [49.1]
120 [48.9]	Sens BTUH [kW]	109.3 [32.0]	99.2 [29.1]	142.5 [41.7]	129.3 [37.9]	165.7 [48.5]	150.4 [44.1]	150.4 [44.1]	137.2 [40.2]	171.7 [50.3]	155.9 [45.7]	172.6 [50.6]	156.7 [45.9]	142.9 [41.9]	142.9 [41.9]
	Power	21.3	20.9	21.2	20.8	21.1	20.7	20.7	20.4	21.0	20.6	21.0	20.6	20.2	20.2
125 [51.7]	Total BTUH [kW]	204.2 [59.8]	196.4 [57.6]	192.7 [56.5]	185.4 [54.3]	183.2 [53.7]	176.2 [51.6]	170.2 [49.9]	166.4 [48.8]	179.1 [52.5]	172.3 [50.5]	175.6 [51.4]	168.9 [49.5]	163.1 [47.8]	163.1 [47.8]
	Sens BTUH [kW]	104.6 [30.6]	94.9 [27.8]	137.7 [40.4]	125.0 [36.6]	160.9 [47.2]	146.1 [42.8]	146.1 [42.8]	133.3 [39.1]	166.9 [48.9]	151.6 [44.4]	167.9 [49.2]	152.4 [44.7]	139.0 [40.7]	139.0 [40.7]
125 [51.7]	Power	22.3	21.9	22.2	21.8	22.1	21.6	21.6	21.3	22.0	21.6	21.9	21.5	21.2	21.2

DR — Depression ratio
dbE — Entering air dry bulb
wbE — Entering air wet bulb

Total — Total capacity x 1000 BTUH
Sens — Sensible capacity x 1000 BTUH
Power — KW Input

NOTES: ① When the entering air dry bulb is other than 80°F [27°C], adjust the sensible capacity from the table by adding $[1.10 \times \text{CFM} \times (1 - \text{DR}) \times (\text{dbE} - 80)]$.

[] Designates Metric Conversions

COOLING PERFORMANCE DATA — RGE2T240A

wB/E		ENTERING INDOOR AIR @ 80°F [26.7°C] dbE ①											
		71°F [21.7°C]		67°F [19.4°C]		63°F [17.2°C]		61°F [16.1°C]		59°F [15.0°C]			
CFM [L/s]		9600 [4531]	7300 [3445]	6400 [3020]	9600 [4531]	7300 [3445]	6400 [3020]	9600 [4531]	7300 [3445]	6400 [3020]	9600 [4531]	7300 [3445]	6400 [3020]
DR ①		0.26	0.23	0.21	0.26	0.23	0.21	0.26	0.23	0.21	0.26	0.23	0.21
75 [23.9]	Total BTUH [kW]	272.2 [79.8]	257.5 [75.5]	251.7 [73.8]	260.6 [76.4]	246.5 [72.2]	241 [70.6]	250.9 [73.5]	237.3 [69.5]	232.0 [68.0]	246.8 [72.3]	233.4 [68.4]	243.2 [71.3]
	Sens BTUH [kW]	151.7 [44.5]	132.3 [38.8]	124.7 [36.5]	183.3 [54.6]	162.4 [47.6]	153 [44.8]	210.4 [61.7]	183.4 [53.8]	172.9 [50.7]	216.7 [63.5]	188.9 [55.4]	217.7 [63.8]
	Power	17.4	16.9	16.8	17.3	16.8	16.6	17.2	16.7	16.5	17.1	16.6	17
80 [26.7]	Total BTUH [kW]	270.1 [79.2]	255.5 [74.9]	249.8 [73.2]	258.5 [75.7]	244.5 [71.6]	239.0 [70]	248.8 [72.9]	235.3 [69]	230.0 [67.4]	244.7 [71.7]	231.4 [67.8]	241 [70.6]
	Sens BTUH [kW]	152.4 [44.7]	132.9 [38.9]	125.2 [36.7]	183.9 [54.8]	163.0 [47.8]	153.6 [45]	211.1 [61.9]	184 [53.9]	173.4 [50.8]	217.3 [63.7]	189.5 [55.5]	218.3 [64]
	Power	18	17.5	17.3	17.9	17.4	17.2	17.8	17.3	17.1	17.7	17.2	17
85 [29.4]	Total BTUH [kW]	267.7 [78.4]	253.2 [74.2]	247.5 [72.5]	256.0 [75.0]	242.2 [71.0]	236.7 [69.4]	246.3 [72.2]	233.0 [68.3]	227.8 [66.7]	242.2 [71.0]	229.1 [67.1]	242.0 [65.6]
	Sens BTUH [kW]	152.4 [44.7]	132.9 [38.9]	125.2 [36.7]	187.0 [54.8]	163.0 [47.8]	153.6 [45]	211.1 [61.9]	184.1 [53.9]	173.5 [50.8]	217.4 [63.7]	189.5 [55.5]	218.4 [64.0]
	Power	18.7	18.2	18	18.6	18.1	17.9	18.4	17.9	17.7	18.4	17.9	18.3
90 [32.2]	Total BTUH [kW]	264.9 [77.6]	250.6 [73.4]	245 [71.8.0]	253.3 [74.2]	239.6 [70.2]	234.2 [69.6]	243.6 [71.4]	230.4 [67.5]	225.2 [66.0]	239.5 [70.2]	226.5 [66.4]	241 [70.6]
	Sens BTUH [kW]	151.9 [44.5]	132.4 [38.8]	124.8 [36.6]	186.4 [54.6]	162.5 [47.6]	153.2 [44.9]	210.6 [61.7]	183.6 [53.8]	173.0 [50.7]	216.8 [63.5]	189.0 [55.4]	217.8 [63.8]
	Power	19.4	18.9	18.6	19.3	18.7	18.5	19.1	18.6	18.4	19.1	18.5	19
95 [35]	Total BTUH [kW]	261.9 [76.7]	247.7 [72.6]	242.2 [71.0]	250.3 [73.3]	236.7 [69.4]	231.4 [67.8]	240.6 [70.5]	227.5 [66.7]	222.4 [65.2]	236.5 [69.3]	223.6 [65.5]	232.8 [68.2]
	Sens BTUH [kW]	150.7 [44.2]	131.4 [38.5]	123.8 [36.3]	185.2 [54.3]	161.5 [47.3]	152.2 [44.6]	209.4 [61.4]	182.5 [53.5]	172.0 [50.4]	215.6 [63.2]	188.0 [55.1]	216.6 [63.5]
	Power	20.1	19.6	19.4	20	19.4	19.2	19.9	19.3	19.1	19.8	19.3	19.1
100 [37.8]	Total BTUH [kW]	258.6 [75.8]	244.5 [71.7]	239.1 [70.1]	246.9 [72.4]	233.5 [68.4]	228.3 [66.9]	237.2 [69.5]	224.4 [65.7]	219.3 [64.3]	233.1 [68.3]	220.5 [67.2]	229.5 [67.2]
	Sens BTUH [kW]	148.8 [43.6]	129.8 [38.0]	122.3 [35.8]	183.4 [53.7]	159.9 [46.9]	150.7 [44.2]	207.6 [60.8]	180.9 [53.0]	170.5 [50.0]	213.8 [62.7]	186.4 [54.6]	214.8 [62.9]
	Power	20.9	20.3	20.1	20.8	20.2	20	20.6	20.1	19.9	20.6	20	20.5
105 [40.6]	Total BTUH [kW]	254.9 [74.7]	241.1 [70.7]	235.7 [69.1]	243.3 [71.3]	230.1 [67.4]	224.9 [65.9]	233.6 [68.4]	220.9 [64.7]	216.0 [63.3]	229.5 [67.2]	217.0 [63.6]	225.8 [66.2]
	Sens BTUH [kW]	146.4 [42.9]	127.6 [37.4]	120.3 [35.3]	180.9 [53.0]	157.8 [46.2]	148.7 [43.6]	205.1 [60.1]	178.8 [52.4]	168.5 [49.4]	211.4 [61.9]	184.3 [54.0]	212.3 [62.2]
	Power	21.7	21.1	20.9	21.6	21	20.8	21.5	20.9	20.7	21.4	20.8	21.3
110 [43.3]	Total BTUH [kW]	250.9 [73.5]	237.4 [69.6]	232.0 [68.0]	239.3 [70.1]	226.3 [66.3]	221.3 [64.8]	229.6 [67.3]	217.2 [63.6]	212.3 [62.2]	225.5 [66.1]	213.3 [62.5]	221.9 [65.0]
	Sens BTUH [kW]	143.4 [42]	125.0 [36.6]	117.8 [34.5]	177.9 [52.1]	155.1 [45.4]	146.2 [42.8]	202.1 [59.2]	176.2 [51.6]	166.0 [48.6]	208.3 [61.0]	181.6 [53.2]	209.3 [61.3]
	Power	22.6	22	21.7	22.4	21.8	21.6	22.3	21.7	21.5	22.3	21.7	22.2
115 [46.1]	Total BTUH [kW]	246.7 [72.3]	233.3 [68.4]	228.1 [66.8]	235.0 [68.9]	222.3 [65.1]	217.3 [63.7]	225.3 [66]	213.1 [62.5]	208.4 [61.1]	221.2 [64.8]	209.2 [61.3]	217.6 [63.8]
	Sens BTUH [kW]	139.7 [40.9]	121.8 [35.7]	114.8 [33.6]	174.2 [51.1]	151.9 [44.5]	143.1 [41.9]	198.4 [58.1]	172.9 [50.7]	163.0 [47.8]	204.6 [60.0]	178.4 [52.3]	205.6 [60.3]
	Power	23.5	22.8	22.6	23.3	22.7	22.5	23.2	22.6	22.3	23.1	22.5	23.1
120 [48.9]	Total BTUH [kW]	242.1 [70.9]	229 [67.1]	223.9 [65.6]	230.5 [67.5]	218.0 [63.9]	213.1 [62.4]	220.8 [64.7]	208.8 [61.2]	204.1 [59.8]	216.7 [63.5]	204.9 [60.1]	213 [62.4]
	Sens BTUH [kW]	135.4 [39.7]	118 [34.6]	111.2 [32.6]	169.9 [49.8]	148.1 [43.4]	139.6 [40.9]	194.1 [56.9]	169.2 [49.6]	159.5 [46.7]	200.3 [58.7]	174.6 [51.2]	201.3 [59]
	Power	24.4	23.7	23.5	24.3	23.6	23.4	24.1	23.5	23.2	24.1	23.4	24
125 [51.7]	Total BTUH [kW]	237.2 [69.5]	224.4 [65.8]	219.4 [64.3]	225.6 [66.1]	213.4 [62.5]	208.6 [61.1]	215.9 [63.3]	204.2 [59.8]	199.6 [58.5]	211.8 [62.1]	200.3 [58.7]	208.2 [61.0]
	Sens BTUH [kW]	130.4 [38.2]	113.7 [33.3]	107.2 [31.4]	165.0 [48.3]	143.8 [42.1]	135.6 [39.7]	189.1 [55.4]	164.9 [48.3]	155.4 [45.5]	195.4 [57.3]	170.3 [49.9]	196.4 [57.5]
	Power	25.4	24.7	24.4	25.2	24.6	24.3	25.1	24.4	24.2	25.1	24.4	25

DR — Depression ratio
dbE — Entering air dry bulb
wB/E — Entering air wet bulb

NOTES: ① When the entering air dry bulb is other than 80°F [27°C], adjust the sensible capacity from the table by adding [1.10 x CFM x (1 - DR) x (dbE - 80)].

[] Designates Metric Conversions

Total — Total capacity x 1000 BTUH
Sens — Sensible capacity x 1000 BTUH
Power — KW input

COOLING PERFORMANCE DATA — RGE2T300A

wB/E		ENTERING INDOOR AIR @ 80°F [26.7°C] dbE ①											
		71°F [21.7°C]		67°F [19.4°C]		63°F [17.2°C]		61°F [16.1°C]		59°F [15.0°C]			
CFM [L/s]		12000 [5663]	8400 [3964]	8000 [3776]	8000 [3964]	8400 [5663]	12000 [5663]	8400 [3964]	8000 [3776]	8000 [3964]	12000 [5663]	8400 [3964]	8000 [3776]
DR ①		0.2	0.16	0.15	0.16	0.2	0.15	0.16	0.15	0.16	0.2	0.16	0.15
75 [23.9]	Total BTUH [kW]	339.6 [95.5]	315 [92.3]	312.3 [91.5]	332.9 [97.6]	327.1 [95.9]	300.5 [88.9]	303.5 [88.9]	300.8 [88.2]	324.7 [95.2]	324.7 [95.2]	298.6 [87.5]	322.7 [94.6]
	Sens BTUH [kW]	242.1 [70.9]	201.7 [59.1]	197.3 [57.8]	255.6 [74.9]	265.9 [77.9]	221.6 [64.9]	216.7 [63.5]	216.7 [63.5]	269.4 [78.9]	269.4 [78.9]	219.5 [64.3]	271.3 [79.5]
	Power	26.4	25.4	25.3	26.3	26.3	25.3	25.2	25.2	26.2	26.2	25.2	26.2
O	Total BTUH [kW]	336.4 [98.6]	312.1 [91.5]	309.4 [90.7]	329.8 [96.6]	324 [94.9]	300.6 [88.1]	298.0 [87.3]	298.0 [87.3]	321.6 [94.2]	321.6 [94.2]	295.8 [86.7]	319.6 [93.7]
U	Sens BTUH [kW]	239.2 [70.1]	199.3 [58.4]	194.9 [57.1]	252.7 [74]	263 [77.1]	219.2 [64.2]	214.3 [62.8]	214.3 [62.8]	266.4 [78.1]	266.4 [78.1]	217.1 [63.6]	288.4 [78.6]
T	Power	26.7	25.7	25.6	26.6	26.5	25.6	25.5	25.4	26.5	26.5	25.5	26.5
D	Total BTUH [kW]	333.3 [97.7]	309.2 [90.6]	306.5 [89.8]	326.6 [95.7]	320.8 [94.0]	297.6 [87.2]	295.1 [86.5]	292.8 [85.8]	318.4 [93.3]	318.4 [93.3]	292.8 [85.8]	316.4 [92.7]
O	Sens BTUH [kW]	236.4 [69.3]	197 [57.7]	192.6 [56.4]	249.9 [73.2]	260.2 [76.2]	216.8 [63.5]	212.0 [62.1]	212.0 [62.1]	263.6 [77.3]	263.6 [77.3]	219.7 [64.4]	285.6 [77.8]
R	Power	27	26	25.9	26.9	26.9	25.9	25.8	25.7	26.8	26.8	25.8	26.8
D	Total BTUH [kW]	330.0 [96.7]	306.2 [89.7]	303.5 [88.9]	323.4 [94.8]	317.6 [93.1]	294.6 [86.3]	292.1 [85.6]	289.9 [84.9]	315.2 [92.4]	315.2 [92.4]	292.4 [85.7]	313.2 [91.8]
R	Sens BTUH [kW]	233.7 [68.5]	194.8 [57.1]	190.4 [55.8]	247.2 [72.4]	257.5 [75.5]	214.6 [62.9]	209.8 [61.5]	209.8 [61.5]	261.0 [76.5]	261.0 [76.5]	217.5 [63.7]	282.9 [77.0]
Y	Power	27.3	26.3	26.2	27.3	27.2	26.2	26.1	26.1	27.2	27.2	26.2	27.1
B	Total BTUH [kW]	326.8 [95.8]	303.1 [88.8]	300.5 [88.1]	320.1 [93.8]	314.3 [92.1]	291.6 [85.4]	289.1 [84.7]	286.8 [84.1]	311.9 [91.4]	311.9 [91.4]	289.4 [84.8]	309.9 [90.8]
U	Sens BTUH [kW]	231.2 [67.7]	192.6 [56.5]	188.4 [55.2]	244.7 [71.7]	255.0 [74.7]	212.5 [62.3]	207.8 [60.9]	207.8 [60.9]	258.5 [75.7]	258.5 [75.7]	215.4 [63.1]	280.4 [76.3]
L	Power	27.7	26.7	26.6	27.6	27.5	26.5	26.4	26.4	27.5	27.5	26.5	27.5
B	Total BTUH [kW]	323.4 [94.8]	300 [87.9]	297.4 [87.2]	316.8 [92.8]	311.0 [91.1]	288.5 [84.5]	286.0 [83.8]	283.8 [83.2]	308.6 [90.4]	308.6 [90.4]	286.3 [83.2]	306.6 [89.8]
L	Sens BTUH [kW]	228.8 [67]	190.7 [55.9]	186.4 [54.6]	242.3 [71.0]	252.6 [74.0]	210.5 [61.7]	205.8 [60.3]	205.8 [60.3]	251.7 [75.0]	251.7 [75.0]	213.4 [62.5]	258.0 [75.6]
B	Power	28.1	27	26.9	28	27.9	26.9	26.8	26.8	27.9	27.9	26.9	27.9
T	Total BTUH [kW]	320 [93.8]	296.9 [87]	294.3 [86.2]	313.4 [91.8]	307.6 [90.1]	285.3 [83.6]	282.9 [82.9]	280.7 [82.2]	305.2 [89.4]	305.2 [89.4]	283.1 [83.0]	303.2 [88.8]
E	Sens BTUH [kW]	226.5 [66.4]	188.8 [55.3]	184.6 [54.1]	240.1 [70.3]	250.4 [73.4]	208.6 [61.1]	204.0 [59.8]	204.0 [59.8]	253.8 [74.4]	253.8 [74.4]	211.5 [62.0]	255.7 [74.9]
M	Power	28.5	27.4	27.3	28.4	28.3	27.3	27.2	27.2	28.3	28.3	27.3	28.3
P	Total BTUH [kW]	316.6 [92.8]	293.7 [86.1]	291.2 [85.3]	309.9 [90.8]	304.1 [89.1]	282.1 [82.7]	279.7 [82.0]	277.5 [81.3]	301.7 [88.4]	301.7 [88.4]	279.9 [82.0]	299.7 [87.8]
E	Sens BTUH [kW]	224.4 [65.8]	187.0 [54.8]	182.9 [53.6]	237.9 [69.7]	248.3 [72.7]	206.9 [60.6]	202.3 [59.3]	202.3 [59.3]	251.7 [73.8]	251.7 [73.8]	209.7 [61.5]	253.6 [74.3]
R	Power	28.9	27.8	27.7	28.8	28.8	27.7	27.6	27.6	28.7	28.7	27.7	28.7
A	Total BTUH [kW]	313.1 [91.7]	290.5 [85.1]	287.9 [84.4]	306.4 [89.8]	300.6 [88.1]	278.9 [81.7]	276.5 [81.0]	274.3 [80.4]	298.2 [87.4]	298.2 [87.4]	276.7 [81.1]	296.2 [86.8]
T	Sens BTUH [kW]	222.4 [65.2]	185.4 [54.3]	181.2 [53.1]	236 [69.1]	246.3 [72.2]	205.2 [60.1]	200.7 [58.8]	200.7 [58.8]	249.7 [73.2]	249.7 [73.2]	208.1 [61.0]	251.6 [73.7]
U	Power	29.3	28.3	28.2	29.3	29.2	28.1	28	28	29.2	29.2	28.1	29.1
R	Total BTUH [kW]	309.5 [90.7]	287.1 [84.1]	284.7 [83.4]	302.9 [88.8]	297.1 [87.1]	275.6 [80.8]	273.2 [80.1]	271 [79.4]	294.7 [86.3]	294.7 [86.3]	273.4 [80.1]	292.7 [85.8]
E	Sens BTUH [kW]	220.6 [64.6]	183.8 [53.9]	179.7 [52.7]	234.1 [68.6]	244.4 [71.6]	203.7 [59.7]	199.2 [58.4]	199.2 [58.4]	247.9 [72.6]	247.9 [72.6]	206.6 [60.5]	249.8 [73.2]
°F	Power	29.8	28.7	28.6	29.8	29.7	28.6	28.5	28.5	29.7	29.7	28.6	29.6
[°C]	Total BTUH [kW]	305.9 [89.6]	283.8 [83.2]	281.3 [82.4]	299.3 [87.7]	293.5 [86.0]	272.2 [79.8]	269.9 [79.1]	267.7 [78.4]	291.0 [85.3]	291.0 [85.3]	270.0 [79.1]	289.1 [84.7]
	Sens BTUH [kW]	218.9 [64.1]	182.4 [53.4]	178.3 [52.3]	232.4 [68.1]	242.7 [71.1]	202.3 [59.3]	197.8 [58.0]	197.8 [58.0]	246.2 [72.1]	246.2 [72.1]	205.1 [60.1]	248.1 [72.7]
	Power	30.3	29.2	29.1	30.3	30.2	29.1	29	28.9	30.2	30.2	29.1	30.1

DR — Depression ratio
dbE — Entering air dry bulb
wB/E — Entering air wet bulb

Total — Total capacity x 1000 BTUH
Sens — Sensible capacity x 1000 BTUH
Power — KW input

NOTES: ① When the entering air dry bulb is other than 80°F [27°C], adjust the sensible capacity from the table by adding [(1.10 x CFM x (1 - DR) x (dbE - 80)).

[] Designates Metric Conversions

COMPONENT AIRFLOW RESISTANCE — 15 TON [52.7 kW]

CFM [L/s]	Resistance — Inches of Water [kPa]													
	4800 [2265]	5000 [2359]	5200 [2454]	5400 [2548]	5600 [2643]	5800 [2737]	6000 [2831]	6200 [2926]	6400 [3020]	6600 [3114]	6800 [3209]	7000 [3303]	7200 [3398]	
Wet Coil	0.01 [.00]	0.02 [.00]	0.02 [.00]	0.03 [.01]	0.03 [.01]	0.04 [.01]	0.04 [.01]	0.04 [.01]	0.05 [.01]	0.05 [.01]	0.06 [.01]	0.06 [.01]	0.06 [.01]	
Downflow Economizer RA Damper Open	0.17 [0.08]	0.18 [0.08]	0.19 [0.08]	0.20 [0.09]	0.21 [0.09]	0.22 [0.10]	0.23 [0.10]	0.24 [0.11]	0.25 [0.11]	0.26 [0.12]	0.27 [0.12]	0.28 [0.12]	0.28 [0.13]	
Horizontal Economizer RA Damper Open	0.70 [0.33]	0.70 [0.33]	0.80 [0.37]	0.80 [0.37]	0.80 [0.37]	0.80 [0.37]	0.80 [0.37]	0.80 [0.37]	0.90 [0.42]	0.90 [0.42]	0.90 [0.42]	0.90 [0.42]	0.90 [0.42]	
MERV 8 Filter	0.075 [0.03]	0.079 [0.03]	0.083 [0.03]	0.087 [0.04]	0.091 [0.04]	0.095 [0.04]	0.099 [0.04]	0.103 [0.04]	0.107 [0.05]	0.111 [0.05]	0.116 [0.05]	0.120 [0.05]	0.124 [0.05]	
MERV 13 Filter	0.019 [0.00]	0.026 [0.01]	0.032 [0.01]	0.038 [0.01]	0.044 [0.02]	0.051 [0.02]	0.057 [0.02]	0.063 [0.02]	0.070 [0.03]	0.076 [0.03]	0.082 [0.03]	0.089 [0.04]	0.095 [0.04]	
Concentric Grill RXRN-AD80 or RXRN-AD81 & Transition RXMC-CJ07	0.21 [.05]	0.25 [.06]	0.28 [.07]	0.32 [.08]	0.35 [.09]	0.39 [.10]	0.43 [.11]	0.46 [.11]	0.50 [.12]	0.54 [.13]	0.57 [.14]	0.61 [.15]	0.64 [.16]	

AIRFLOW CORRECTION FACTORS — 15 TON [52.7 kW]

CFM [L/s]	4800 [2265]	5000 [2359]	5200 [2454]	5400 [2548]	5600 [2643]	5800 [2737]	6000 [2831]	6200 [2926]	6400 [3020]	6600 [3114]	6800 [3209]	7000 [3303]	7200 [3398]
Total MBH	0.97	0.98	0.98	0.99	0.99	1.00	1.00	1.01	1.02	1.02	1.03	1.03	1.04
Sensible MBH	0.89	0.91	0.93	0.95	0.97	0.99	1.01	1.03	1.05	1.07	1.09	1.11	1.13
Power kW	0.98	0.99	0.99	0.99	1.00	1.00	1.00	1.01	1.01	1.01	1.02	1.02	1.02

NOTE: Multiply correction factor times gross performance data - resulting sensible capacity cannot exceed total capacity.

[] Designates Metric Conversions

COMPONENT AIRFLOW RESISTANCE — 15 TON [52.7 kW]

CFM [L/s]	Resistance — Inches of Water [kPa]													
	4800 [2265]	5000 [2359]	5200 [2454]	5400 [2548]	5600 [2643]	5800 [2737]	6000 [2831]	6200 [2926]	6400 [3020]	6600 [3114]	6800 [3209]	7000 [3303]	7200 [3398]	
Wet Coil	0.01 [.00]	0.02 [.00]	0.02 [.00]	0.03 [.01]	0.03 [.01]	0.04 [.01]	0.04 [.01]	0.04 [.01]	0.05 [.01]	0.05 [.01]	0.06 [.01]	0.06 [.01]	0.06 [.01]	
Downflow Economizer RA Damper Open	0.17 [0.08]	0.18 [0.08]	0.19 [0.08]	0.20 [0.09]	0.21 [0.09]	0.22 [0.10]	0.23 [0.10]	0.24 [0.11]	0.25 [0.11]	0.26 [0.12]	0.27 [0.12]	0.28 [0.13]	0.28 [0.13]	
Horizontal Economizer RA Damper Open	0.70 [0.33]	0.70 [0.33]	0.80 [0.37]	0.80 [0.37]	0.80 [0.37]	0.80 [0.37]	0.80 [0.37]	0.80 [0.37]	0.90 [0.42]	0.90 [0.42]	0.90 [0.42]	0.90 [0.42]	0.90 [0.42]	
MERV 8 Filter	0.075 [0.03]	0.079 [0.03]	0.083 [0.03]	0.087 [0.04]	0.091 [0.04]	0.095 [0.04]	0.099 [0.04]	0.103 [0.04]	0.107 [0.05]	0.111 [0.05]	0.116 [0.05]	0.120 [0.05]	0.124 [0.05]	
MERV 13 Filter	0.019 [0.00]	0.026 [0.01]	0.032 [0.01]	0.038 [0.01]	0.044 [0.02]	0.051 [0.02]	0.057 [0.02]	0.063 [0.02]	0.070 [0.03]	0.076 [0.03]	0.082 [0.03]	0.089 [0.04]	0.095 [0.04]	
Concentric Grill RXRN-AD80 or RXRN-AD81 & Transition RXMC-CJ07	0.21 [.05]	0.25 [.06]	0.28 [.07]	0.32 [.08]	0.35 [.09]	0.39 [.10]	0.43 [.11]	0.46 [.11]	0.50 [.12]	0.54 [.13]	0.57 [.14]	0.61 [.15]	0.64 [.16]	

AIRFLOW CORRECTION FACTORS — 15 TON [52.7 kW]

CFM [L/s]	4800 [2265]	5000 [2359]	5200 [2454]	5400 [2548]	5600 [2643]	5800 [2737]	6000 [2831]	6200 [2926]	6400 [3020]	6600 [3114]	6800 [3209]	7000 [3303]	7200 [3398]
Total MBH	0.97	0.98	0.98	0.99	0.99	1.00	1.00	1.01	1.02	1.02	1.03	1.03	1.04
Sensible MBH	0.89	0.91	0.93	0.95	0.97	0.99	1.01	1.03	1.05	1.07	1.09	1.11	1.13
Power kW	0.98	0.99	0.99	0.99	1.00	1.00	1.00	1.01	1.01	1.01	1.02	1.02	1.02

NOTE: Multiply correction factor times gross performance data - resulting sensible capacity cannot exceed total capacity.

[] Designates Metric Conversions

COMPONENT AIRFLOW RESISTANCE— 17.5 TON [61.5 kW] — 60 Hz — DOWNFLOW (Con't.)

CFM [L/s]	Resistance — Inches of Water [kPa]															
	5600 [2643]	5800 [2737]	6000 [2831]	6200 [2926]	6400 [3020]	6600 [3114]	6800 [3209]	7000 [3303]	7200 [3398]	7400 [3492]	7600 [3586]	7800 [3681]	8000 [3775]	8200 [3869]	8400 [3964]	
Wet Coil	0.03 [.01]	0.04 [.01]	0.04 [.01]	0.04 [.01]	0.05 [.01]	0.05 [.01]	0.06 [.01]	0.06 [.01]	0.06 [.01]	0.07 [.02]	0.07 [.02]	0.08 [.02]	0.08 [.02]	0.08 [.02]	0.09 [.02]	
Downflow Economizer RA Damper Open	0.21 [0.09]	0.22 [0.01]	0.23 [0.01]	0.24 [0.01]	0.25 [0.01]	0.26 [0.01]	0.27 [0.01]	0.28 [0.01]	0.28 [0.01]	0.29 [0.01]	0.30 [0.01]	0.31 [0.01]	0.32 [0.01]	0.33 [0.01]	0.33 [0.01]	
Horizontal Economizer RA Damper Open	0.08 [0.03]	0.08 [0.03]	0.08 [0.03]	0.08 [0.03]	0.09 [0.04]	0.09 [0.04]	0.09 [0.04]	0.09 [0.04]	0.09 [0.04]	0.09 [0.04]	0.10 [0.04]	0.10 [0.04]	0.10 [0.04]	0.10 [0.04]	0.10 [0.04]	
MERV 8 Filter	0.091 [0.04]	0.095 [0.04]	0.099 [0.04]	0.103 [0.04]	0.107 [0.05]	0.111 [0.05]	0.116 [0.05]	0.120 [0.05]	0.124 [0.05]	0.128 [0.06]	0.132 [0.06]	0.136 [0.06]	0.140 [0.06]	0.144 [0.06]	0.148 [0.06]	
MERV 13 Filter	0.044 [0.02]	0.051 [0.02]	0.057 [0.02]	0.063 [0.02]	0.070 [0.03]	0.076 [0.03]	0.082 [0.03]	0.089 [0.04]	0.095 [0.04]	0.101 [0.04]	0.107 [0.05]	0.114 [0.05]	0.120 [0.05]	0.126 [0.05]	0.133 [0.06]	
Concentric Grill RXRN-AD80 or RXRN-AD81 & Transition RXWC-CJ07	0.35 [.09]	0.39 [.10]	0.43 [.11]	0.46 [.11]	0.50 [.12]	0.54 [.13]	0.57 [.14]	0.61 [.15]	0.64 [.16]	0.68 [.17]	0.72 [.18]	0.75 [.19]	0.79 [.20]	0.83 [.21]	0.86 [.21]	

AIRFLOW CORRECTION FACTORS— 17.5 TON [61.5 kW]

CFM [L/s]	5600 [2643]	5800 [2737]	6000 [2831]	6200 [2926]	6400 [3020]	6600 [3114]	6800 [3209]	7000 [3303]	7200 [3398]	7400 [3492]	7600 [3586]	7800 [3681]	8000 [3775]	8200 [3869]	8400 [3964]
Total MBH	0.97	0.97	0.98	0.98	0.99	0.99	1.00	1.00	1.01	1.01	1.02	1.02	1.03	1.03	1.04
Sensible MBH	0.87	0.89	0.91	0.93	0.95	0.97	0.99	1.01	1.03	1.05	1.07	1.09	1.11	1.13	1.15
Power kW	0.98	0.99	0.99	0.99	0.99	1.00	1.00	1.00	1.00	1.01	1.01	1.01	1.01	1.02	1.02

NOTE: Multiply correction factor times gross performance data - resulting sensible capacity cannot exceed total capacity.

[] Designates Metric Conversions

COMPONENT AIRFLOW RESISTANCE— 17.5 TON [61.5 kW] — 60 HZ — SIDEFLOW

CFM [L/s]	Resistance — Inches of Water [kPa]														
	5600 [2643]	5800 [2737]	6000 [2831]	6200 [2926]	6400 [3020]	6600 [3114]	6800 [3209]	7000 [3303]	7200 [3398]	7400 [3492]	7600 [3586]	7800 [3681]	8000 [3775]	8200 [3869]	8400 [3964]
Wet Coil	0.03 [.01]	0.04 [.01]	0.04 [.01]	0.04 [.01]	0.05 [.01]	0.05 [.01]	0.06 [.01]	0.06 [.01]	0.06 [.01]	0.07 [.02]	0.07 [.02]	0.08 [.02]	0.08 [.02]	0.08 [.02]	0.09 [.02]
Downflow Economizer RA Damper Open	0.21 [0.09]	0.22 [0.01]	0.23 [0.01]	0.24 [0.01]	0.25 [0.01]	0.26 [0.01]	0.26 [0.01]	0.27 [0.01]	0.28 [0.01]	0.29 [0.01]	0.30 [0.01]	0.31 [0.01]	0.32 [0.01]	0.33 [0.01]	0.33 [0.01]
Horizontal Economizer RA Damper Open	0.08 [0.03]	0.08 [0.03]	0.08 [0.03]	0.08 [0.03]	0.09 [0.04]	0.09 [0.04]	0.09 [0.04]	0.09 [0.04]	0.09 [0.04]	0.09 [0.04]	0.10 [0.04]	0.10 [0.04]	0.10 [0.04]	0.10 [0.04]	0.10 [0.04]
MERV 8 Filter	0.091 [0.04]	0.095 [0.04]	0.099 [0.04]	0.103 [0.04]	0.107 [0.05]	0.111 [0.05]	0.116 [0.05]	0.120 [0.05]	0.124 [0.05]	0.128 [0.06]	0.132 [0.06]	0.136 [0.06]	0.140 [0.06]	0.144 [0.06]	0.148 [0.06]
MERV 13 Filter	0.044 [0.02]	0.051 [0.02]	0.057 [0.02]	0.063 [0.02]	0.070 [0.03]	0.076 [0.03]	0.082 [0.03]	0.089 [0.04]	0.095 [0.04]	0.101 [0.04]	0.107 [0.05]	0.114 [0.05]	0.120 [0.05]	0.126 [0.05]	0.133 [0.06]
Concentric Grill RXRN-AD80 or RXRN-AD81 & Transition RXWC-CJ07	0.35 [.09]	0.39 [.10]	0.43 [.11]	0.46 [.11]	0.50 [.12]	0.54 [.13]	0.57 [.14]	0.61 [.15]	0.64 [.16]	0.68 [.17]	0.72 [.18]	0.75 [.19]	0.79 [.20]	0.83 [.21]	0.86 [.21]

AIRFLOW CORRECTION FACTORS— 17.5 TON [61.5 kW]

CFM	5600	5800	6000	6200	6400	6600	6800	7000	7200	7400	7600	7800	8000	8200	8400
[L/s]	[2643]	[2737]	[2831]	[2926]	[3020]	[3114]	[3209]	[3303]	[3398]	[3492]	[3586]	[3681]	[3775]	[3869]	[3964]
Total MBH	0.97	0.97	0.98	0.98	0.99	0.99	1.00	1.00	1.01	1.01	1.02	1.02	1.03	1.03	1.04
Sensible MBH	0.87	0.89	0.91	0.93	0.95	0.97	0.99	1.01	1.03	1.05	1.07	1.09	1.11	1.13	1.15
Power kW	0.98	0.99	0.99	0.99	0.99	1.00	1.00	1.00	1.00	1.01	1.01	1.01	1.01	1.02	1.02

NOTE: Multiply correction factor times gross performance data - resulting sensible capacity cannot exceed total capacity.

[] Designates Metric Conversions

AIRFLOW PERFORMANCE—20 TON [70.3 kW] — 60 Hz — DOWNFLOW (Con't.)

F		G										H		
Drive Package														
Motor H.P. [W]	5 [3728.5]	5 [3728.5]										7.5 [5592.7]		
Motor RPM	1755	1755										1760		
Blower Sheave	BK105	BK90										BK105		
Motor Frame Size	184	184										213		
Motor Sheave	1VP-56	1VP-56										1VP71		
Turns Open	0	1	2	3	4	5	6	0	1	2	3	4	5	6
RPM	917	884	854	822	792	761	761	943	909	875	875	1045	1018	978

- NOTES: 1. Factory sheave settings are shown in bold type.
 2. Do not set motor sheave below minimum or maximum turns open shown.
 3. Re-adjustment of sheave required to achieve rated airflow at AHRI minimum External Static Pressure
 4. Drive data shown is for horizontal airflow with dry coil. Add component resistance (below) to duct resistance to determine total External Static Pressure.
 5. An RPM meter must be used to receive an accurate airflow reading.

COMPONENT AIRFLOW RESISTANCE—20 TON [70.3 kW] — 60 Hz — DOWNFLOW

CFM [L/s]	Resistance — Inches of Water [kPa]																
	6400 [3020]	6600 [3114]	6800 [3209]	7000 [3303]	7200 [3398]	7400 [3492]	7600 [3586]	7800 [3681]	8000 [3775]	8200 [3869]	8400 [3964]	8600 [4058]	8800 [4153]	9000 [4247]	9200 [4341]	9400 [4436]	9600 [4530]
Wet Coil	0.08 [0.02]	0.09 [0.02]	0.09 [0.02]	0.09 [0.02]	0.09 [0.02]	0.10 [0.02]	0.10 [0.02]	0.10 [0.02]	0.10 [0.02]	0.11 [0.03]	0.11 [0.03]	0.11 [0.03]	0.11 [0.03]	0.12 [0.03]	0.12 [0.03]	0.12 [0.03]	0.12 [0.03]
Downflow Economizer RA Damper Open	0.25 [0.11]	0.26 [0.12]	0.26 [0.12]	0.27 [0.12]	0.28 [0.13]	0.29 [0.13]	0.30 [0.14]	0.31 [0.14]	0.32 [0.15]	0.33 [0.15]	0.33 [0.15]	0.34 [0.16]	0.35 [0.16]	0.36 [0.16]	0.37 [0.17]	0.38 [0.17]	0.39 [0.18]
Horizontal Economizer RA Damper Open	0.09 [0.04]	0.09 [0.04]	0.09 [0.04]	0.09 [0.04]	0.09 [0.04]	0.10 [0.04]	0.10 [0.04]	0.10 [0.04]	0.10 [0.04]	0.10 [0.04]	0.10 [0.04]	0.10 [0.04]	0.10 [0.04]	0.11 [0.05]	0.11 [0.05]	0.11 [0.05]	0.11 [0.05]
MERV 8 Filter	0.107 [0.05]	0.111 [0.05]	0.116 [0.05]	0.120 [0.05]	0.124 [0.05]	0.128 [0.06]	0.132 [0.06]	0.136 [0.06]	0.140 [0.06]	0.144 [0.06]	0.148 [0.06]	0.152 [0.07]	0.156 [0.07]	0.160 [0.07]	0.164 [0.07]	0.169 [0.08]	0.173 [0.08]
MERV 13 Filter	0.070 [0.03]	0.076 [0.03]	0.082 [0.03]	0.089 [0.04]	0.095 [0.04]	0.101 [0.04]	0.107 [0.05]	0.114 [0.05]	0.120 [0.05]	0.126 [0.05]	0.133 [0.06]	0.139 [0.06]	0.145 [0.06]	0.151 [0.07]	0.158 [0.07]	0.164 [0.08]	0.170 [0.08]
Concentric Grill RXRN-AD86 & Transition RXMC-CK08	0.26 [0.06]	0.29 [0.07]	0.32 [0.08]	0.35 [0.09]	0.38 [0.09]	0.41 [0.10]	0.44 [0.11]	0.47 [0.12]	0.50 [0.12]	0.53 [0.13]	0.56 [0.14]	0.60 [0.15]	0.63 [0.16]	0.66 [0.16]	0.69 [0.17]	0.72 [0.18]	0.75 [0.19]

AIRFLOW CORRECTION FACTORS—20 TON [70.3 kW]

CFM [L/s]	6400 [3020]	6600 [3114]	6800 [3209]	7000 [3303]	7200 [3398]	7400 [3492]	7600 [3586]	7800 [3681]	8000 [3775]	8200 [3869]	8400 [3964]	8600 [4058]	8800 [4153]	9000 [4247]	9200 [4341]	9400 [4436]	9600 [4530]
Total MBH	0.98	0.98	0.99	0.99	1.00	1.00	0.96	0.97	0.97	0.98	0.98	0.98	0.99	0.99	0.99	1.00	1.00
Sensible MBH	0.91	0.93	0.95	0.97	0.99	1.01	1.03	1.05	1.07	1.09	1.11	1.13	1.15	1.17	1.19	1.21	1.23
Power kW	0.99	0.99	0.99	1.00	1.00	1.00	1.00	1.01	1.01	1.01	1.01	1.02	1.02	1.02	1.02	1.03	1.03

NOTE: Multiply correction factor times gross performance data - resulting sensible capacity cannot exceed total capacity.

[] Designates Metric Conversions

AIRFLOW PERFORMANCE—20 TON [70.3 kW] — 60 Hz — SIDEFLOW (Con't.)

F		G										H		
Drive Package														
Motor H.P. [W]	5 [3728.5]	5 [3728.5]										7.5 [5592.7]		
Motor RPM	1755	1755										1760		
Blower Sheave	BK105	BK90										BK105		
Motor Frame Size	184	184										213		
Motor Sheave	1VP-56	1VP-56										1VP71		
Turns Open	0	1	2	3	4	5	6	0	1	2	3	4	5	6
RPM	919	885	857	827	797	764	764	1047	1002	975	938	901	871	871

- NOTES: 1. Factory sheave settings are shown in bold type.
 2. Do not set motor sheave below minimum or maximum turns open shown.
 3. Re-adjustment of sheave required to achieve rated airflow at AHRI minimum External Static Pressure.
 4. Drive data shown is for horizontal airflow with dry coil. Add component resistance (below) to duct resistance to determine total External Static Pressure.
 5. An RPM meter must be used to receive an accurate airflow reading.

COMPONENT AIRFLOW RESISTANCE—20 TON [70.3 kW] — 60 Hz — SIDEFLOW

CFM [L/s]	Resistance — Inches of Water [kPa]																
	6400 [3020]	6600 [3114]	6800 [3209]	7000 [3303]	7200 [3398]	7400 [3492]	7600 [3586]	7800 [3681]	8000 [3775]	8200 [3869]	8400 [3964]	8600 [4058]	8800 [4153]	9000 [4247]	9200 [4341]	9400 [4436]	9600 [4530]
Wet Coil	0.08 [0.02]	0.09 [0.02]	0.09 [0.02]	0.09 [0.02]	0.09 [0.02]	0.10 [0.02]	0.10 [0.02]	0.10 [0.02]	0.10 [0.02]	0.11 [0.03]	0.11 [0.03]	0.11 [0.03]	0.11 [0.03]	0.11 [0.03]	0.12 [0.03]	0.12 [0.03]	0.12 [0.03]
Downflow Economizer RA Damper Open	0.25 [0.11]	0.26 [0.12]	0.26 [0.12]	0.27 [0.12]	0.28 [0.13]	0.29 [0.13]	0.30 [0.14]	0.31 [0.14]	0.32 [0.15]	0.33 [0.15]	0.33 [0.15]	0.34 [0.16]	0.35 [0.16]	0.36 [0.16]	0.37 [0.17]	0.38 [0.17]	0.39 [0.18]
Horizontal Economizer RA Damper Open	0.09 [0.04]	0.09 [0.04]	0.09 [0.04]	0.09 [0.04]	0.09 [0.04]	0.10 [0.04]	0.10 [0.04]	0.10 [0.04]	0.10 [0.04]	0.10 [0.04]	0.10 [0.04]	0.10 [0.04]	0.10 [0.04]	0.11 [0.05]	0.11 [0.05]	0.11 [0.05]	0.11 [0.05]
MERV 8 Filter	0.107 [0.05]	0.111 [0.05]	0.116 [0.05]	0.120 [0.05]	0.124 [0.05]	0.128 [0.06]	0.132 [0.06]	0.136 [0.06]	0.140 [0.06]	0.144 [0.06]	0.148 [0.06]	0.152 [0.07]	0.156 [0.07]	0.160 [0.07]	0.164 [0.07]	0.169 [0.08]	0.173 [0.08]
MERV 13 Filter	0.070 [0.03]	0.076 [0.03]	0.082 [0.03]	0.089 [0.04]	0.095 [0.04]	0.101 [0.04]	0.107 [0.05]	0.114 [0.05]	0.120 [0.05]	0.126 [0.05]	0.133 [0.06]	0.139 [0.06]	0.145 [0.06]	0.151 [0.07]	0.158 [0.07]	0.164 [0.08]	0.170 [0.08]
Concentric Grill RXRN-AD86 & Transition RXMC-CK08	0.26 [0.06]	0.29 [0.07]	0.32 [0.08]	0.35 [0.09]	0.38 [0.09]	0.41 [0.10]	0.44 [0.11]	0.47 [0.12]	0.50 [0.12]	0.53 [0.13]	0.56 [0.14]	0.60 [0.15]	0.63 [0.16]	0.66 [0.16]	0.69 [0.17]	0.72 [0.18]	0.75 [0.19]

AIRFLOW CORRECTION FACTORS—20 TON [70.3 kW]

CFM [L/s]	6400 [3020]	6600 [3114]	6800 [3209]	7000 [3303]	7200 [3398]	7400 [3492]	7600 [3586]	7800 [3681]	8000 [3775]	8200 [3869]	8400 [3964]	8600 [4058]	8800 [4153]	9000 [4247]	9200 [4341]	9400 [4436]	9600 [4530]
Total MBH	0.98	0.98	0.99	0.99	1.00	1.00	0.96	0.97	0.97	0.98	0.98	0.98	0.99	0.99	0.99	1.00	1.00
Sensible MBH	0.91	0.93	0.95	0.97	0.99	1.01	1.03	1.05	1.07	1.09	1.11	1.13	1.15	1.17	1.19	1.21	1.23
Power kW	0.99	0.99	0.99	1.00	1.00	1.00	1.00	1.01	1.01	1.01	1.01	1.02	1.02	1.02	1.02	1.03	1.03

NOTE: Multiply correction factor times gross performance data - resulting sensible capacity cannot exceed total capacity.

[] Designates Metric Conversions

AIRFLOW PERFORMANCE — 25 TON [87.9 kW] — 60 Hz — DOWNFLOW (Con't.)

Drive Package	F						G						H								
	0	1	2	3	4	5	6	0	1	2	3	4	5	6	0	1	2	3	4	5	6
Motor H.P. [W]	7.5 [5592.7]						10 [7457.0]						10 [7457.0]								
Motor RPM	1760						1760						1760								
Blower Sheave	BK110						BK105						BK95								
Motor Frame Size	213						215						215								
Motor Sheave	1VP-65						1VP-71						1VP71								
Turns Open	0	1	2	3	4	5	6	0	1	2	3	4	5	6	0	1	2	3	4	5	6
RPM	998	967	935	903	873	842	842	811	780	749	718	687	656	625	625	594	563	532	501	470	439

- NOTES: 1. Factory sheave settings are shown in bold type.
 2. Do not set motor sheave below minimum or maximum turns open shown.
 3. Re-adjustment of sheave required to achieve rated airflow at AHRI minimum External Static Pressure.
 4. Drive data shown is for horizontal airflow with dry coil. Add component resistance (below) to duct resistance to determine total External Static Pressure.
 5. An RPM meter must be used to receive an accurate airflow reading.

COMPONENT AIRFLOW RESISTANCE — 25 TON [87.9 kW]

CFM [L/s]	8000	8400	8800	9200	9600	10000	10400	10800	11200	11600	12000
	[3775]	[3964]	[4153]	[4341]	[4530]	[4719]	[4908]	[5096]	[5285]	[5474]	[5663]
Resistance — Inches of Water [kPa]											
Wet Coil	0.10 [.03]	0.11 [.03]	0.11 [.03]	0.12 [.03]	0.12 [.03]	0.13 [.03]	0.14 [.03]	0.14 [.03]	0.15 [.04]	0.15 [.04]	0.16 [.04]
Downflow Economizer RA Damper Open	0.32 [0.15]	0.33 [0.15]	0.35 [0.16]	0.37 [0.17]	0.39 [0.18]	0.40 [0.18]	0.42 [0.19]	0.44 [0.20]	0.46 [0.21]	0.47 [0.22]	0.49 [0.23]
Horizontal Economizer RA Damper Open	0.10 [0.04]	0.10 [0.05]	0.10 [0.05]	0.11 [0.05]	0.11 [0.05]	0.11 [0.05]	0.12 [0.05]	0.12 [0.05]	0.12 [0.05]	0.13 [0.06]	0.13 [0.06]
MERV 8 Filter	0.140 [0.06]	0.148 [0.06]	0.156 [0.07]	0.164 [0.07]	0.173 [0.08]	0.181 [0.08]	0.189 [0.08]	0.197 [0.09]	0.205 [0.09]	0.213 [0.10]	0.221 [0.10]
MERV 13 Filter	0.120 [0.05]	0.133 [0.06]	0.145 [0.06]	0.158 [0.07]	0.170 [0.08]	0.183 [0.08]	0.196 [0.09]	0.208 [0.09]	0.221 [0.10]	0.233 [0.10]	0.246 [0.11]
Concentric Grill RXRN-AD86 & Transition RXMCMC-CL09	0.17 [.04]	0.23 [.06]	0.30 [.07]	0.36 [.09]	0.43 [.11]	0.50 [.12]	0.56 [.14]	0.63 [.16]	0.69 [.17]	0.76 [.19]	0.82 [.20]

AIRFLOW CORRECTION FACTORS — 125 TON [87.9 kW]

CFM	8000	8400	8800	9200	9600	10000	10400	10800	11200	11600	12000
[L/s]	[3775]	[3964]	[4153]	[4341]	[4530]	[4719]	[4908]	[5096]	[5285]	[5474]	[5663]
Total MBH	0.99	1.00	1.01	1.02	1.03	1.04	1.05	1.06	1.07	1.08	1.09
Sensible MBH	0.97	1.00	1.03	1.06	1.09	1.12	1.15	1.18	1.21	1.24	1.27
Power kW	1.00	1.00	1.00	1.01	1.01	1.01	1.02	1.02	1.02	1.03	1.03

NOTE: Multiply correction factor times gross performance data - resulting sensible capacity cannot exceed total capacity.

[] Designates Metric Conversions

AIRFLOW PERFORMANCE — 25 TON [87.9 kW] — 60 Hz — SIDEFLOW (Con't.)

Drive Package	F						G						H										
	0	1	2	3	4	5	0	1	2	3	4	5	0	1	2	3	0	1	2	3	4	5	6
Motor H.P. [W]	7.5 [5592.7]						10 [7457.0]						10 [7457.0]										
Motor RPM	1760						1760						1760										
Blower Sheave	BK110						BK105						BK95										
Motor Frame Size	213						215						215										
Motor Sheave	1VP-65						1VP-71						1VP71										
Turns Open	0	1	2	3	4	5	0	1	2	3	4	5	0	1	2	3	0	1	2	3	4	5	6
RPM	933	962	902	872	841	811	1134	1108	1068	1046	1016	984	1255	1215	1179	1148	1255	1215	1179	1148	1114	1078	1038

- NOTES: 1. Factory sheave settings are shown in bold type.
 2. Do not set motor sheave below minimum or maximum turns open shown.
 3. Re-adjustment of sheave required to achieve rated airflow at AHRI minimum External Static Pressure.
 4. Drive data shown is for horizontal airflow with dry coil. Add component resistance (below) to duct resistance to determine total External Static Pressure.
 5. An RPM meter must be used to receive an accurate airflow reading.

COMPONENT AIRFLOW RESISTANCE — 25 TON [87.9 kW]

CFM [L/s]	Resistance — Inches of Water [kPa]											
	8000 [3775]	8400 [3964]	8800 [4153]	9200 [4341]	9600 [4530]	10000 [4719]	10400 [4908]	10800 [5096]	11200 [5285]	11600 [5474]	12000 [5663]	
Wet Coil	0.10 [.03]	0.11 [.03]	0.11 [.03]	0.12 [.03]	0.12 [.03]	0.13 [.03]	0.14 [.03]	0.14 [.03]	0.15 [.04]	0.15 [.04]	0.16 [.04]	
Downflow Economizer RA Damper Open	0.32 [.15]	0.33 [.15]	0.35 [.16]	0.37 [.17]	0.39 [.18]	0.40 [.18]	0.42 [.19]	0.44 [.20]	0.46 [.21]	0.47 [.22]	0.49 [.23]	
Horizontal Economizer RA Damper Open	0.10 [.04]	0.10 [.05]	0.10 [.05]	0.11 [.05]	0.11 [.05]	0.11 [.05]	0.12 [.05]	0.12 [.05]	0.12 [.05]	0.13 [.06]	0.13 [.06]	
MERV 8 Filter	0.140 [.06]	0.148 [.06]	0.156 [.07]	0.164 [.07]	0.173 [.08]	0.181 [.08]	0.189 [.08]	0.197 [.09]	0.205 [.09]	0.213 [.10]	0.221 [.10]	
MERV 13 Filter	0.120 [.05]	0.133 [.06]	0.145 [.06]	0.158 [.07]	0.170 [.08]	0.183 [.08]	0.196 [.09]	0.208 [.09]	0.221 [.10]	0.233 [.10]	0.246 [.11]	
Concentric Grill RXRN-AD86 & Transition RXMCM-CL09	0.17 [.04]	0.23 [.06]	0.30 [.07]	0.36 [.09]	0.43 [.11]	0.50 [.12]	0.56 [.14]	0.63 [.16]	0.69 [.17]	0.76 [.19]	0.82 [.20]	

AIRFLOW CORRECTION FACTORS — 125 TON [87.9 kW]

CFM [L/s]	8000 [3775]	8400 [3964]	8800 [4153]	9200 [4341]	9600 [4530]	10000 [4719]	10400 [4908]	10800 [5096]	11200 [5285]	11600 [5474]	12000 [5663]
Total MBH	0.99	1.00	1.01	1.02	1.03	1.04	1.05	1.06	1.07	1.08	1.09
Sensible MBH	0.97	1.00	1.03	1.06	1.09	1.12	1.15	1.18	1.21	1.24	1.27
Power kW	1.00	1.00	1.00	1.01	1.01	1.01	1.02	1.02	1.02	1.03	1.03

NOTE: Multiply correction factor times gross performance data - resulting sensible capacity cannot exceed total capacity.

[] Designates Metric Conversions

ELECTRICAL DATA – RGE2T SERIES WITHOUT EXHAUST

	180ACF	180ACG	180ACH	180ADF	180ADG	180ADH	180AYF	180AYG	180AYH
Unit Information	Unit Operating Voltage Range	187-253	187-253	414-506	414-506	414-506	517-633	517-633	517-633
	Volts	208/230	208/230	208/230	460	460	575	575	575
	Phase	3	3	3	3	3	3	3	3
	Hz	60	60	60	60	60	60	60	60
	Minimum Circuit Ampacity	74/74	79/79	80/80	38	40	40	28	30
	Minimum Overcurrent Protection Device Size	90/90	90/90	90/90	45	45	45	30	35
	Maximum Overcurrent Protection Device Size	90/90	100/100	100/100	50	50	50	35	35
	No.	2	2	2	2	2	2	2	2
	Volts	200/230	200/230	200/230	460	460	460	575	575
	Phase	3	3	3	3	3	3	3	3
Compressor Motor	RPM	3500	3500	3500	3500	3500	3500	3500	3500
	HP, Compressor 1	6	6	6	6	6	6	6	6
	Amps (RLA), Comp. 1	25	25	25	12.8	12.8	12.8	9.6	9.6
	Amps (LRA), Comp. 1	164	164	164	100	100	100	78	78
	HP, Compressor 2	6	6	6	6	6	6	6	6
	Amps (RLA), Comp. 2	25	25	25	12.8	12.8	12.8	9.6	9.6
	Amps (LRA), Comp. 2	164	164	164	100	100	100	78	78
	No.	2	2	2	2	2	2	2	2
	Volts	208/230	208/230	208/230	460	460	460	575	575
	Phase	1	1	1	1	1	1	1	1
Condenser Motor	HP	3/4	3/4	3/4	3/4	3/4	3/4	3/4	3/4
	Amps (FLA, each)	4.2	4.2	4.2	2.3	2.3	2.3	1.2	1.2
	Amps (LRA, each)	10.1	10.1	10.1	4.9	4.9	4.9	3.4	3.4
	No.	1	1	1	1	1	1	1	1
	Volts	208/230	208/230	208/230	460	460	460	575	575
	Phase	3	3	3	3	3	3	3	3
	HP	3	5	5	3	5	5	3	5
	Amps (FLA, each)	9.2	13.6	13.6	4.6	6.3	6.3	3.5	5.1
	Amps (LRA, each)	74.5	95.0	95.0	38.1	47.5	47.5	30.0	38.0
	Evaporator Fan	No.	1	1	1	1	1	1	1
Volts		208/230	208/230	208/230	460	460	460	575	575
Phase		3	3	3	3	3	3	3	3
HP		3	5	5	3	5	5	3	5
Amps (FLA, each)		9.2	13.6	13.6	4.6	6.3	6.3	3.5	5.1
Amps (LRA, each)		74.5	95.0	95.0	38.1	47.5	47.5	30.0	38.0

ELECTRICAL DATA – RGE2T SERIES WITH EXHAUST

	180ACF	180ACG	180ACH	180ADF	180ADG	180ADH	180AYF	180AYG	180AYH
Unit Information	Unit Operating Voltage Range	187-253	187-253	414-506	414-506	414-506	517-633	517-633	517-633
	Volts	208/230	208/230	460	460	460	575	575	575
	Phase	3	3	3	3	3	3	3	3
	Hz	60	60	60	60	60	60	60	60
Unit Information	Minimum Circuit Ampacity	79/79	85/85	40	42	42	30	31	31
	Minimum Overcurrent Protection Device Size	90/90	100/100	45	45	45	35	35	35
	Maximum Overcurrent Protection Device Size	100/100	100/100	50	50	50	35	40	40
	No.	2	2	2	2	2	2	2	2
Compressor Motor	Volts	200/230	200/230	460	460	460	575	575	575
	Phase	3	3	3	3	3	3	3	3
	RPM	3500	3500	3500	3500	3500	3500	3500	3500
	HP, Compressor 1	6	6	6	6	6	6	6	6
	Amps (RLA), Comp. 1	25	25	12.8	12.8	12.8	9.6	9.6	9.6
	Amps (LRA), Comp. 1	164	164	100	100	100	78	78	78
	HP, Compressor 2	6	6	6	6	6	6	6	6
	Amps (RLA), Comp. 2	25	25	12.8	12.8	12.8	9.6	9.6	9.6
	Amps (LRA), Comp. 2	164	164	100	100	100	78	78	78
	No.	2	2	2	2	2	2	2	2
Condenser Motor	Volts	208/230	208/230	460	460	460	575	575	575
	Phase	1	1	1	1	1	1	1	1
	HP	3/4	3/4	3/4	3/4	3/4	3/4	3/4	3/4
	Amps (FLA, each)	4.2	4.2	2.3	2.3	2.3	1.2	1.2	1.2
	Amps (LRA, each)	10.1	10.1	4.9	4.9	4.9	3.4	3.4	3.4
	No.	1	1	1	1	1	1	1	1
Evaporator Fan	Volts	208/230	208/230	460	460	460	575	575	575
	Phase	3	3	3	3	3	3	3	3
	HP	3	5	5	3	5	3	5	5
	Amps (FLA, each)	9.2	13.6	13.6	4.6	6.3	3.5	5.1	5.1
	Amps (LRA, each)	74.5	95.0	95.0	38.1	47.5	30.0	38.0	38.0

ELECTRICAL DATA – RGE2T SERIES WITHOUT EXHAUST

	210ACF	210ACG	210ACH	210ADF	210ADG	210ADH	210AYF	210AYG	210AYH	
Unit Information	Unit Operating Voltage Range	187-253	187-253	414-506	414-506	414-506	517-633	517-633	517-633	
	Volts	208/230	208/230	208/230	460	460	575	575	575	
	Phase	3	3	3	3	3	3	3	3	
	Hz	60	60	60	60	60	60	60	60	
	Minimum Circuit Ampacity	83/83	87/87	95/95	39	41	44	30	32	34
	Minimum Overcurrent Protection Device Size	90/90	100/100	110/110	45	45	50	35	35	40
Compressor Motor	Maximum Overcurrent Protection Device Size	100/100	110/110	50	50	50	35	40	40	
	No.	2	2	2	2	2	2	2	2	
	Volts	200/230	200/230	200/230	460	460	575	575	575	
	Phase	3	3	3	3	3	3	3	3	
	RPM	3500	3500	3500	3500	3500	3500	3500	3500	
	HP, Compressor 1	7 1/2	7 1/2	7 1/2	7 1/2	7 1/2	7 1/2	7 1/2	7 1/2	
Condenser Motor	Amps (RLA), Comp. 1	27.6	27.6	27.6	12.8	12.8	9.6	9.6	9.6	
	Amps (LRA), Comp. 1	191	191	191	100	100	78	78	78	
	HP, Compressor 2	7 1/2	7 1/2	7 1/2	7 1/2	7 1/2	7 1/2	7 1/2	7 1/2	
	Amps (RLA), Comp. 2	27.6	27.6	27.6	12.8	12.8	9.6	9.6	9.6	
	Amps (LRA), Comp. 2	191	191	191	100	100	78	78	78	
	No.	2	2	2	2	2	2	2	2	
Evaporator Fan	Volts	208/230	208/230	460	460	460	575	575	575	
	Phase	3	3	3	3	3	3	3	3	
	HP	1 1/2	1 1/2	1 1/2	1 1/2	1 1/2	1 1/2	1 1/2	1 1/2	
	Amps (FLA, each)	5.5	5.5	5.5	2.7	2.7	2.7	2.2	2.2	
	Amps (LRA, each)	28.6	28.6	28.6	14.3	14.3	14.3	11	11	
	No.	1	1	1	1	1	1	1	1	
Evaporator Fan	Volts	208/230	208/230	460	460	460	575	575	575	
	Phase	3	3	3	3	3	3	3	3	
	HP	3	5	7.5	3	5	7.5	3	5	
	Amps (FLA, each)	9.2	13.6	21	4.6	6.3	9.6	3.5	5.1	
	Amps (LRA, each)	74.5	95	127	38.1	47.5	63.5	30.0	38.0	
										50.8

ELECTRICAL DATA – RGE2T SERIES WITH EXHAUST

	210ACF	210ACG	210ACH	210ADF	210ADG	210ADH	210AYF	210AYG	210AYH
Unit Information	Unit Operating Voltage Range	187-253	187-253	414-506	414-506	414-506	517-633	517-633	517-633
	Volts	208/230	208/230	460	460	460	575	575	575
Unit Information	Phase	3	3	3	3	3	3	3	3
	Hz	60	60	60	60	60	60	60	60
Unit Information	Minimum Circuit Ampacity	87/87	99/99	41	43	46	32	33	36
	Minimum Overcurrent Protection Device Size	100/100	110/110	45	50	50	35	40	40
Unit Information	Maximum Overcurrent Protection Device Size	110/110	125/125	50	50	50	40	40	45
	No.	2	2	2	2	2	2	2	2
Compressor Motor	Volts	200/230	200/230	460	460	460	575	575	575
	Phase	3	3	3	3	3	3	3	3
Compressor Motor	RPM	3500	3500	3500	3500	3500	3500	3500	3500
	HP, Compressor 1	7 1/2	7 1/2	7 1/2	7 1/2	7 1/2	7 1/2	7 1/2	7 1/2
Compressor Motor	Amps (RLA), Comp. 1	27.6	27.6	12.8	12.8	12.8	9.6	9.6	9.6
	Amps (LRA), Comp. 1	191	191	100	100	100	78	78	78
Compressor Motor	HP, Compressor 2	7 1/2	7 1/2	7 1/2	7 1/2	7 1/2	7 1/2	7 1/2	7 1/2
	Amps (RLA), Comp. 2	27.6	27.6	12.8	12.8	12.8	9.6	9.6	9.6
Compressor Motor	Amps (LRA), Comp. 2	191	191	100	100	100	78	78	78
	No.	2	2	2	2	2	2	2	2
Condenser Motor	Volts	208/230	208/230	460	460	460	575	575	575
	Phase	3	3	3	3	3	3	3	3
Condenser Motor	HP	1 1/2	1 1/2	1 1/2	1 1/2	1 1/2	1 1/2	1 1/2	1 1/2
	Amps (FLA, each)	5.5	5.5	2.7	2.7	2.7	2.2	2.2	2.2
Condenser Motor	Amps (LRA, each)	28.6	28.6	14.3	14.3	14.3	11	11	11
	No.	1	1	1	1	1	1	1	1
Evaporator Fan	Volts	208/230	208/230	460	460	460	575	575	575
	Phase	3	3	3	3	3	3	3	3
Evaporator Fan	HP	3	7.5	3	5	7.5	3	5	7.5
	Amps (FLA, each)	9.2	13.6	4.6	6.3	9.6	3.5	5.1	7.7
Evaporator Fan	Amps (LRA, each)	74.5	95	38.1	47.5	63.5	30.0	38.0	50.8
	No.	1	1	1	1	1	1	1	1

ELECTRICAL DATA – RGE2T SERIES WITHOUT EXHAUST

	240ACF	240ACG	240ACH	240ADF	240ADG	240ADH	240AYF	240AYG	240AYH	
Unit Information	Unit Operating Voltage Range	187-253	187-253	414-506	414-506	414-506	517-633	517-633	517-633	
	Volts	208/230	208/230	460	460	460	575	575	575	
	Phase	3	3	3	3	3	3	3	3	
	Hz	60	60	60	60	60	60	60	60	
	Minimum Circuit Ampacity	89/89	89/89	96/96	45	45	49	35	35	38
	Minimum Overcurrent Protection Device Size	100/100	100/100	110/110	50	50	60	40	40	45
Compressor Motor	Maximum Overcurrent Protection Device Size	110/110	110/110	60	60	60	45	45	50	
	No.	2	2	2	2	2	2	2	2	
	Volts	200/230	200/230	200/230	460	460	460	575	575	
	Phase	3	3	3	3	3	3	3	3	
	RPM	3500	3500	3500	3500	3500	3500	3500	3500	
	HP, Compressor 1	10	10	10	10	10	10	10	10	
Condenser Motor	Amps (RLA), Comp. 1	28.2	28.2	14.7	14.7	14.7	11.3	11.3	11.3	
	Amps (LRA), Comp. 1	240	240	130	130	130	93.7	93.7	93.7	
	HP, Compressor 2	10	10	10	10	10	10	10	10	
	Amps (RLA), Comp. 2	28.2	28.2	14.7	14.7	14.7	11.3	11.3	11.3	
	Amps (LRA), Comp. 2	240	240	130	130	130	93.7	93.7	93.7	
	No.	2	2	2	2	2	2	2	2	
Evaporator Fan	Volts	208/230	208/230	460	460	460	575	575	575	
	Phase	3	3	3	3	3	3	3	3	
	HP	1 1/2	1 1/2	1 1/2	1 1/2	1 1/2	1 1/2	1 1/2	1 1/2	
	Amps (FLA, each)	5.5	5.5	5.5	2.7	2.7	2.7	2.2	2.2	
	Amps (LRA, each)	28.6	28.6	28.6	14.3	14.3	14.3	11	11	
	No.	1	1	1	1	1	1	1	1	
Evaporator Fan	Volts	208/230	208/230	460	460	460	575	575	575	
	Phase	3	3	3	3	3	3	3	3	
	HP	5	5	7.5	5	5	7.5	5	7.5	
	Amps (FLA, each)	13.6	13.6	21	6.3	6.3	9.6	5.1	7.7	
	Amps (LRA, each)	95	95	127	47.5	47.5	63.5	38.0	50.8	
	No.	95	95	127	47.5	47.5	63.5	38.0	50.8	

ELECTRICAL DATA – RGE2T SERIES WITH EXHAUST

	240ACF	240ACG	240ACH	240ADF	240ADG	240ADH	240AYF	240AYG	240AYH
Unit Information	Unit Operating Voltage Range	187-253	187-253	414-506	414-506	414-506	517-633	517-633	517-633
	Volts	208/230	208/230	460	460	460	575	575	575
	Phase	3	3	3	3	3	3	3	3
	Hz	60	60	60	60	60	60	60	60
	Minimum Circuit Ampacity	93/93	101/101	47	47	50	37	37	40
	Minimum Overcurrent Protection Device Size	100/100	100/100	110/110	50	50	40	40	45
	Maximum Overcurrent Protection Device Size	110/110	110/110	125/125	60	60	60	45	50
Compressor Motor	No.	2	2	2	2	2	2	2	2
	Volts	200/230	200/230	460	460	460	575	575	575
	Phase	3	3	3	3	3	3	3	3
	RPM	3500	3500	3500	3500	3500	3500	3500	3500
	HP, Compressor 1	10	10	10	10	10	10	10	10
	Amps (RLA), Comp. 1	28.2	28.2	28.2	14.7	14.7	14.7	11.3	11.3
	Amps (LRA), Comp. 1	240	240	240	130	130	130	93.7	93.7
	HP, Compressor 2	10	10	10	10	10	10	10	10
	Amps (RLA), Comp. 2	28.2	28.2	28.2	14.7	14.7	14.7	11.3	11.3
	Amps (LRA), Comp. 2	240	240	240	130	130	130	93.7	93.7
Condenser Motor	No.	2	2	2	2	2	2	2	2
	Volts	208/230	208/230	460	460	460	575	575	575
	Phase	3	3	3	3	3	3	3	3
	HP	1 1/2	1 1/2	1 1/2	1 1/2	1 1/2	1 1/2	1 1/2	1 1/2
	Amps (FLA, each)	5.5	5.5	5.5	2.7	2.7	2.7	2.2	2.2
	Amps (LRA, each)	28.6	28.6	28.6	14.3	14.3	14.3	11	11
	No.	1	1	1	1	1	1	1	1
Evaporator Fan	Volts	208/230	208/230	460	460	460	575	575	575
	Phase	3	3	3	3	3	3	3	3
	HP	5	7.5	7.5	5	5	5	5	7.5
	Amps (FLA, each)	13.6	13.6	21	6.3	6.3	5.1	5.1	7.7
	Amps (LRA, each)	95	95	127	47.5	47.5	38.0	38.0	50.8

ELECTRICAL DATA – RGE2T SERIES WITHOUT EXHAUST

	300ACF	300ACG	300ACH	300ADF	300ADG	300ADH	300AYF	300AYG	300AYH	
Unit Information	Unit Operating Voltage Range	187-253	187-253	414-506	414-506	414-506	517-633	517-633	517-633	
	Volts	208/230	208/230	208/230	460	460	575	575	575	
	Phase	3	3	3	3	3	3	3	3	
	Hz	60	60	60	60	60	60	60	60	
	Minimum Circuit Ampacity	147/147	147/147	147/147	57	60	46	60	48	48
	Minimum Overcurrent Protection Device Size	175/175	175/175	175/175	70	70	60	60	60	60
Compressor Motor	Maximum Overcurrent Protection Device Size	175/175	175/175	70	70	70	60	60	60	
	No.	2	2	2	2	2	2	2	2	
	Volts	200/230	200/230	200/230	460	460	575	575	575	
	Phase	3	3	3	3	3	3	3	3	
	RPM	3500	3500	3500	3500	3500	3500	3500	3500	
	HP, Compressor 1	11 1/2	11 1/2	11 1/2	11 1/2	11 1/2	11 1/2	11 1/2	11 1/2	
Condenser Motor	Amps (RLA), Comp. 1	48.1	48.1	18.6	18.6	18.6	14.7	14.7	14.7	
	Amps (LRA), Comp. 1	245	245	125	125	125	100	100	100	
	HP, Compressor 2	11 1/2	11 1/2	11 1/2	11 1/2	11 1/2	11 1/2	11 1/2	11 1/2	
	Amps (RLA), Comp. 2	48.1	48.1	18.6	18.6	18.6	14.7	14.7	14.7	
	Amps (LRA), Comp. 2	245	245	125	125	125	100	100	100	
	No.	2	2	2	2	2	2	2	2	
Evaporator Fan	Volts	208/230	208/230	460	460	460	575	575	575	
	Phase	3	3	3	3	3	3	3	3	
	HP	1 1/2	1 1/2	1 1/2	1 1/2	1 1/2	1 1/2	1 1/2	1 1/2	
	Amps (FLA, each)	5.5	5.5	5.5	2.7	2.7	2.2	2.2	2.2	
	Amps (LRA, each)	28.6	28.6	28.6	14.3	14.3	11	11	11	
	No.	1	1	1	1	1	1	1	1	
Evaporator Fan	Volts	208/230	208/230	460	460	460	575	575	575	
	Phase	3	3	3	3	3	3	3	3	
	HP	7.5	10	10	7.5	10	7.5	10	10	
	Amps (FLA, each)	21	27	27	9.6	12.5	7.7	10	10	
	Amps (LRA, each)	127	152	152	63.5	76	50.8	60.8	60.8	

ELECTRICAL DATA – RGE2T SERIES WITH EXHAUST

	300ACF	300ACG	300ACH	300ADF	300ADG	300ADH	300AYF	300AYG	300AYH	
Unit Information	Unit Operating Voltage Range	187-253	187-253	414-506	414-506	414-506	517-633	517-633	517-633	
	Volts	208/230	208/230	460	460	460	575	575	575	
	Phase	3	3	3	3	3	3	3	3	
	Hz	60	60	60	60	60	60	60	60	
	Minimum Circuit Ampacity	145/145	151/151	152/152	59	62	62	48	50	50
	Minimum Overcurrent Protection Device Size	175/175	175/175	175/175	70	70	70	60	60	60
Maximum Overcurrent Protection Device Size	175/175	175/175	175/175	70	70	70	60	60	60	
Compressor Motor	No.	2	2	2	2	2	2	2	2	
	Volts	200/230	200/230	460	460	460	575	575	575	
	Phase	3	3	3	3	3	3	3	3	
	RPM	3500	3500	3500	3500	3500	3500	3500	3500	
	HP, Compressor 1	11 1/2	11 1/2	11 1/2	11 1/2	11 1/2	11 1/2	11 1/2	11 1/2	
	Amps (RLA), Comp. 1	48.1	48.1	48.1	18.6	18.6	18.6	14.7	14.7	
	Amps (LRA), Comp. 1	245	245	245	125	125	125	100	100	
	HP, Compressor 2	11 1/2	11 1/2	11 1/2	11 1/2	11 1/2	11 1/2	11 1/2	11 1/2	
	Amps (RLA), Comp. 2	48.1	48.1	48.1	18.6	18.6	18.6	14.7	14.7	
	Amps (LRA), Comp. 2	245	245	245	125	125	125	100	100	
Condenser Motor	No.	2	2	2	2	2	2	2	2	
	Volts	208/230	208/230	460	460	460	575	575	575	
	Phase	3	3	3	3	3	3	3	3	
	HP	1 1/2	1 1/2	1 1/2	1 1/2	1 1/2	1 1/2	1 1/2	1 1/2	
	Amps (FLA, each)	5.5	5.5	5.5	2.7	2.7	2.7	2.2	2.2	
	Amps (LRA, each)	28.6	28.6	28.6	14.3	14.3	14.3	11	11	
Evaporator Fan	No.	1	1	1	1	1	1	1	1	
	Volts	208/230	208/230	460	460	460	575	575	575	
	Phase	3	3	3	3	3	3	3	3	
	HP	7.5	10	10	7.5	10	10	7.5	10	
	Amps (FLA, each)	21	27	27	9.6	12.5	12.5	7.7	10	
	Amps (LRA, each)	127	152	152	63.5	76	76	50.8	60.8	

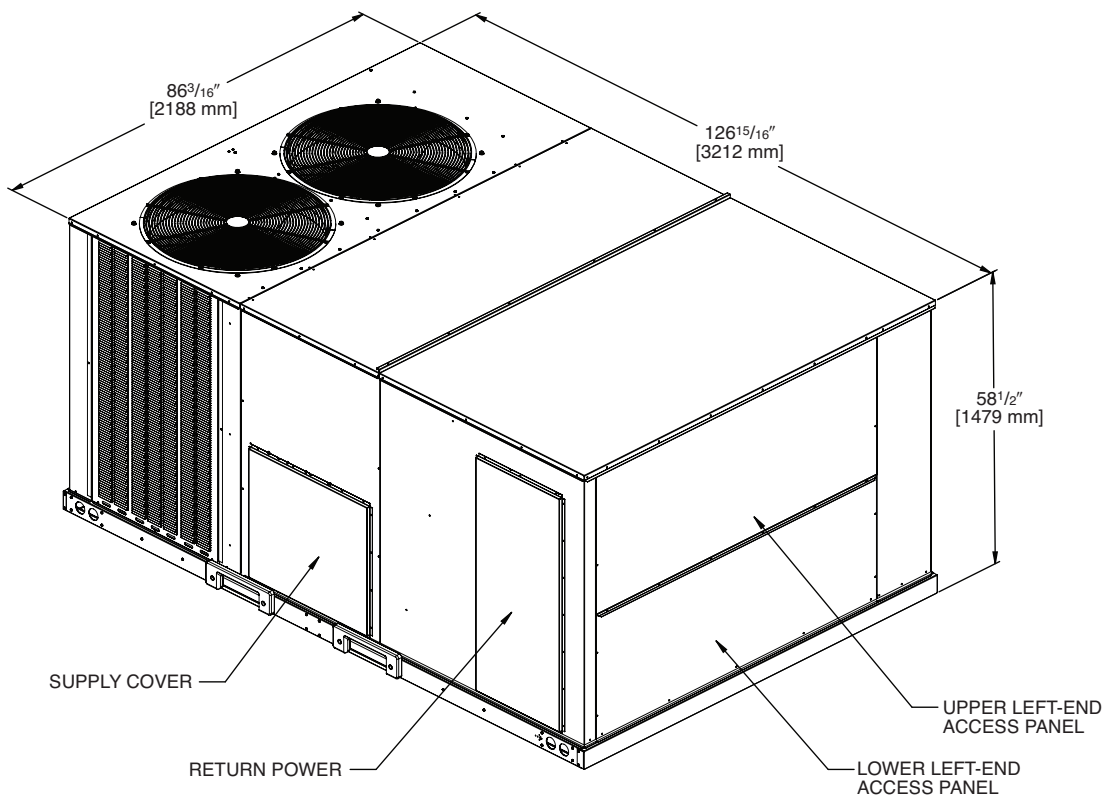

Illustration
ST-A1321-02

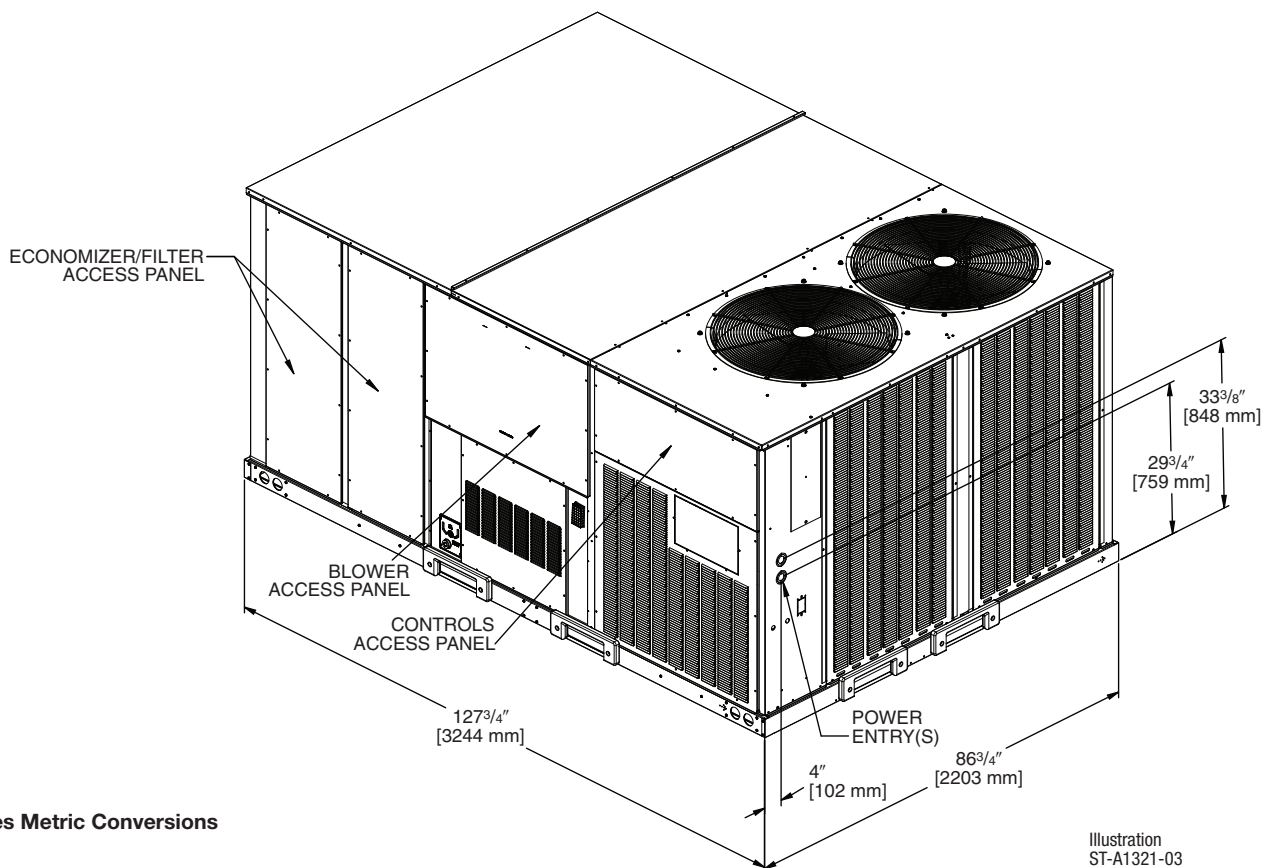

Illustration
ST-A1321-03

[] Designates Metric Conversions

SUPPLY AND RETURN DIMENSIONS FOR HORIZONTAL APPLICATIONS

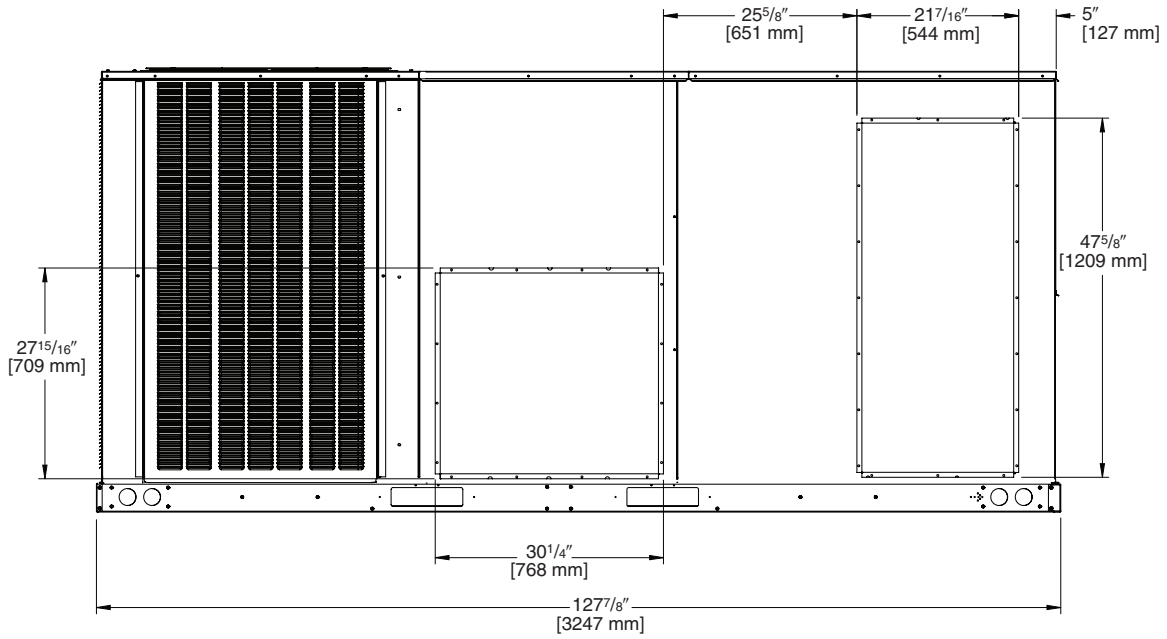

Illustration
ST-A1321-05

SUPPLY AND RETURN DIMENSIONS FOR DOWNFLOW APPLICATIONS

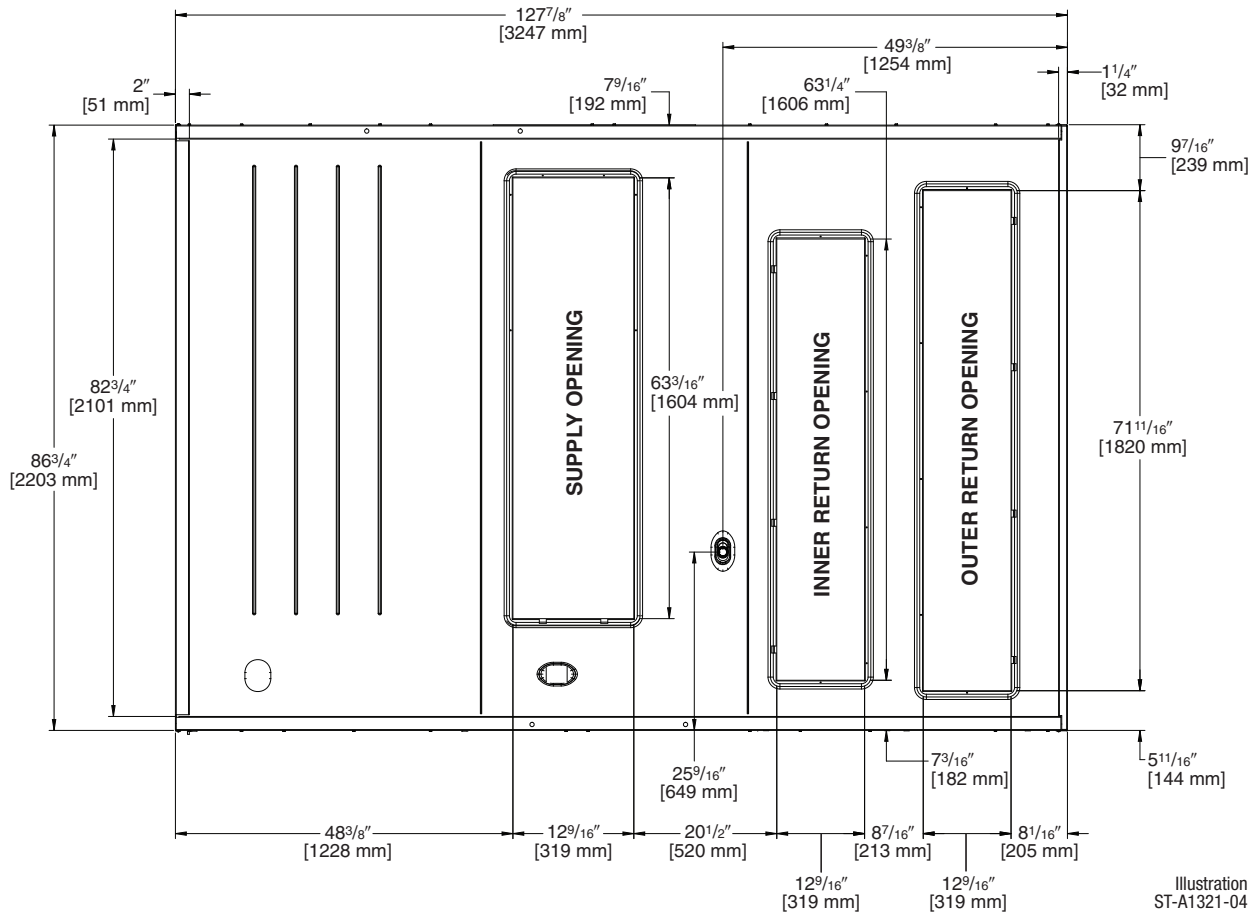
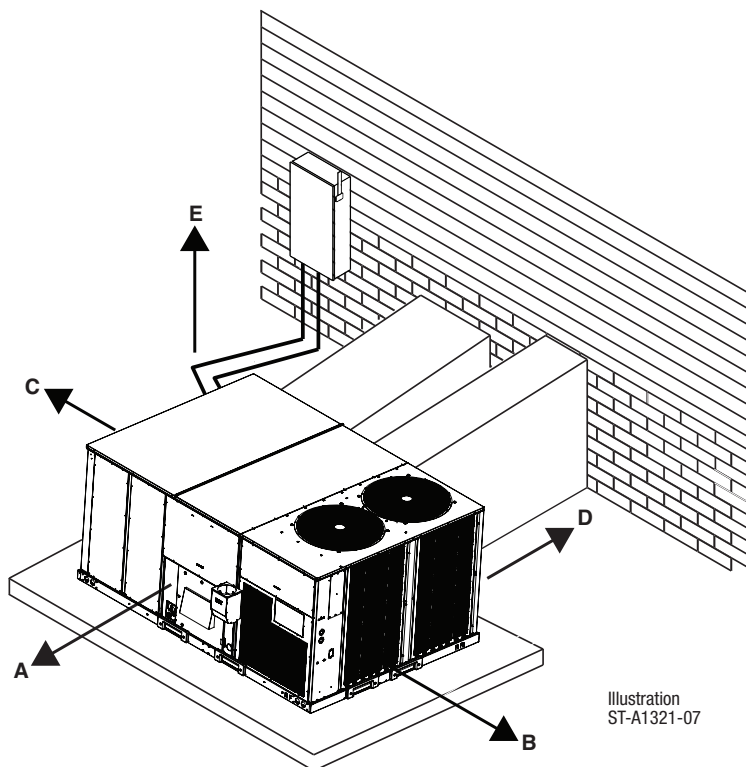
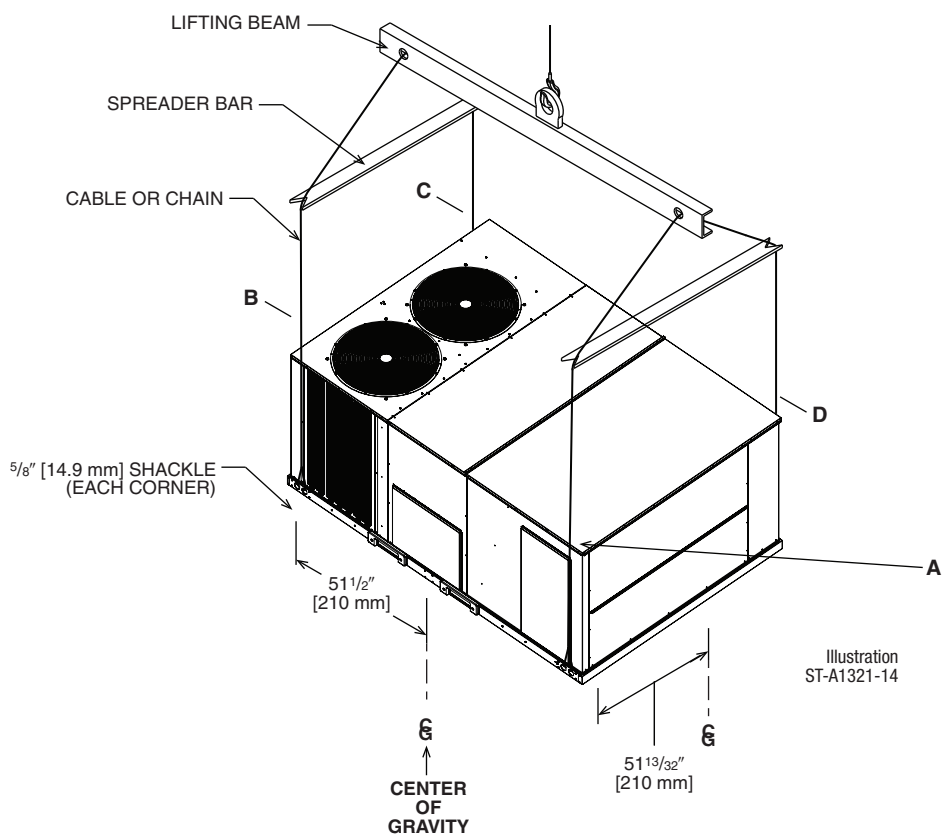

Illustration
ST-A1321-04

[] Designates Metric Conversions

WEIGHTS

Capacity Tons [kW]	Corner Weights by Percentage			
	A	B	C	D
15.0-25.0 [52.8-87.9]	27%	14%	45%	14%



CLEARANCES

The following minimum clearances must be observed for proper unit performance and serviceability.

RECOMMENDED CLEARANCE In. [mm]	LOCATION
80 [2032] ①	A - FRONT
36 [914]	B - CONDENSER END
48 [1219]	C - ECONOMIZER
24 [609] ②	D - DUCT SIDE
60 [1524]	E - ABOVE

① 18" [457 mm] MINIMUM IF DRAINPAN WILL NOT BE REMOVED.

② 48" [1219 mm] MINIMUM IF ECONOMIZER IS INSTALLED.

[] Designates Metric Conversions

COMMUNICATION CARDS



BACnet® COMMUNICATION CARD RXXR-AY01

The field installed BACnet® Communication Card allows the RTU-C unit controller to communicate with a third party building management system that supports the BACnet Application Specific Controller device profile. The BACnet® Communication Module plugs onto the unit RTU-C controller and allows communication between the RTU-C and the BACnet MSTP network.

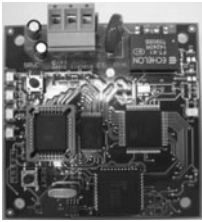

LonWorks® COMMUNICATION CARD RXXR-AY02

The field installed LonWorks® Communication Card allows the RTU-C unit controller to communicate with a third party building management system that supports the LonMark Space Comfort Controller (SCC) functional profile or LonMark Discharge Air Controller (DAC) functional profile. The LonMark Communication Module plugs onto the RTU-C controller and allows communication between the RTU-C and a LonWorks Network.

FIELD-INSTALLED ACCESSORY EQUIPMENT

Accessory	Model Number	Shipping Weight Lbs. [kg]	Installed Weight Lbs. [kg]	Factory Installation Available?
Economizer w/Single Enthalpy (Downflow/Vertical)	RXRD-01MGDAM3	445 [202]	269 [122.1]	Yes
Economizer w/Single Enthalpy (Horizontal)	RXRD-01MGHAM3			No
Economizer w/Single Enthalpy (Downflow/Vertical) DDC	RXRD-01MGDBM3	445 [202]	269 [122.1]	Yes
Economizer w/Single Enthalpy (Horizontal) DDC	RXRD-01MGHBM3	616 [279.7]	427.3 [194]	No
Dual Enthalpy Kit	RXRX-BV01	1 [0.5]	1 [0.5]	No
Dual Enthalpy Kit DDC	RXRX-BV02	1 [0.5]	1 [0.5]	No
Power Exhaust (230V)	RXRX-CGF01C	104 [47.2]	98.65 [44.8]	No
Power Exhaust (460V)	RXRX-CGF01D	97 [44]	91.65 [41.6]	No
Power Exhaust (575V)	RXRX-CGF01Y	140 [63.6]	134.65 [61.1]	No
Manual Fresh Air Damper	RXRF-AGA1	110 [49.9]	104 [47.2]	No
Motorized Fresh Air Damper	RXRF-AGB1	118 [53.6]	112 [50.8]	No
Motorized Fresh Air Damper DDC	RXRF-AGC1	118 [53.6]	112 [50.8]	No
Roofcurb, 14"	RXRX-DGC14	210 [95.3]	205 [93.1]	No
Roofcurb, 18"	RXRX-DGC18	250 [113.5]	245 [111.2]	No
Roofcurb, 24"	RXRX-DGC24	293 [133]	288 [130.8]	No
Roofcurb - Restraint Clips	RXRX-DGCRC	8.5 [3.9]	7.5 [3.4]	No
Roofcurb Adapter	RXRX-DCGCAE	358 [162.5]	350 [158.9]	No
Roofcurb Adapter Z-Bracket	RXRX-DGCAZ	60 [27.2]	42 [19.1]	No
Concentric Flush Mount Diffuser (15 & 17.5 ton)	RXRN-AEF2042	240 [109]	220 [99.9]	No
Concentric Flush Mount Diffuser (20 ton)	RXRN-AEF2348	270 [122.6]	250 [113.5]	No
Concentric Flush Mount Diffuser (25 ton)	RXRN-AEF2852	335 [152.1]	315 [143]	No
Concentric Step Down Diffuser (15 & 17.5 ton)	RXRN-AED2042	350 [158.9]	330 [149.8]	No
Concentric Step Down Diffuser (20 ton)	RXRN-AED2348	405 [183.9]	385 [174.8]	No
Concentric Step Down Diffuser (25 ton)	RXRN-AED2852	410 [186.1]	390 [177.1]	No
Concentric Adapter/Transition (15 & 17.5 ton)	RXMC-GG01	468 [212.5]	450 [204.3]	No
Concentric Adapter/Transition (20 ton)	RXMC-GG02	468 [212.5]	450 [204.3]	No
Concentric Adapter/Transition (25 ton)	RXMC-GG03	468 [212.5]	450 [204.3]	No
Flue Diverter Kit	RXRX-DGG05			No
Outdoor Coil Louver Kit	RXRX-LKG01	94.5 [42.9]	90 [40.9]	No
Non-Powered Convenience Outlet	RXRX-BN01	2.2 [1]	2 [0.9]	No
Comfort Alert (3 phase) Non-DDC	RXRX-AZG1	1 [0.5]	1 [0.5]	No
Comfort Alert (3 Phase) DDC	RXRX-AZG2	1 [0.5]	1 [0.5]	No
Carbon Dioxide Sensor (Wall Mount)	RXRX-AR02	1 [0.5]	1 [0.5]	No
BACnet Communicator Card	RXRX-AY01	1 [0.5]	1 [0.5]	No
LonWorks Communication Card	RXRX-AY02	1 [0.5]	1 [0.5]	No
Room Humidity Sensor	RHC-ZNS4	1 [0.5]	1 [0.5]	No
Room Temperature and Humidity Sensor	RHC-ZNS5	1 [0.5]	1 [0.5]	No
Low-Ambient Control Kit	RXRZ-A05	3 [1.4]	2 [0.9]	Yes
Freeze Stat Kit	RXRX-AM05	1 [0.5]	1 [0.5]	Yes
Return Smoke Detector (Downflow/Vertical)	RXRX-BSG1	7 [3.2]	6 [2.7]	Yes
Return Smoke Detector (Horizontal)	RXRX-BSG2	7 [3.2]	6 [2.7]	Yes
Return/Supply Smoke Detector (Downflow/Vertical)	RXRX-BSG3	10 [4.5]	9 [4.1]	Yes
Return/Supply Smoke Detector (Horizontal)	RXRX-BSG4	10 [4.5]	9 [4.1]	Yes
MERV 8 Filter	RXMF-M08A22420	8 [3.6]	7 [3.2]	No
MERV 13 Filter	RXMF-M13A22420	8 [3.6]	7 [3.2]	No

[] Designates Metric Conversions

Guide Specifications RGEG

You may copy this document directly into your building specification. This specification is written to comply with the 2016 version of the “master format” as published by the Construction Specification Institute. www.csinet.org.

GAS HEAT PACKAGED ROOFTOP

HVAC Guide Specifications

Size Range: 15 to 25 Nominal Tons

Section	Description
---------	-------------

23 06 80	Schedules for Decentralized HVAC Equipment
-----------------	---

23 06 80.13	Decentralized Unitary HVAC Equipment Schedule
--------------------	--

23 06 80.13.A.	Rooftop unit schedule
----------------	-----------------------

1. Schedule is per the project specification requirements.

23 07 16	HVAC Equipment Insulation
-----------------	----------------------------------

23 07 16.00.A.	Evaporator fan compartment:
----------------	-----------------------------

1. Interior cabinet surfaces shall be insulated with a minimum 1/2-in. thick, minimum 1.6 LB density, flexible fiberglass insulation bonded with foil face on the air side.
2. Insulation and adhesive shall meet NFPA 90A requirements for flame spread and smoke generation.
3. Insulation shall also be mechanically fastened with welded pin and retainer washer.

23 07 16.00.B.	Gas heat compartment:
----------------	-----------------------

1. Aluminum foil-faced fiberglass insulation shall be used.
2. Insulation and adhesive shall meet NFPA 90A requirements for flame spread and smoke generation.
3. Insulation shall also be mechanically fastened with welded pin and retainer washer.

23 09 13	Instrumentation and Control Devices for HVAC
-----------------	---

23 09 13.23	Sensors and Transmitters:
--------------------	----------------------------------

23 09 13.23.A.	Thermostats
----------------	-------------

1. Thermostat must
 - a. Energize “G” when calling for heat. If “G” signal is provided along with “W1” or “W2,” then the warm-up delay is bypassed.
 - b. Have capability to energize 2 different stages of cooling, and 2 different stages of heating.
 - c. Must include capability for occupancy scheduling.

23 09 23	Direct-Digital Control System for HVAC
-----------------	---

23 09 23.00.A.	RTU-C controller
----------------	------------------

1. Shall be ASHRAE 62-2001 compliant.
2. Shall accept 18-32VAC input power.
3. Shall have an operating temperature range from -40°F (-40°C) to 125°F (52°C), 10%– 95% RH (non-condensing).
4. Controller shall accept the following inputs: space temperature, setpoint adjustment, outdoor air temperature, indoor air quality, outdoor air enthalpy, fire shutdown, return air enthalpy, fan status, remote time clock/door switch.
5. Shall accept a CO₂ sensor in the conditioned space and be Demand Control Ventilation (DCV) ready.
6. Shall provide the following outputs: Economizer, fan, cooling stage 1, cooling stage 2, heat stage 1, heat stage 2, exhaust, occupied.
7. Unit shall provide surge protection for the controller through a circuit breaker.
8. Shall have a field installed communication card allowing the unit to be able to communicate at a Baud rate of 19.2K or faster.
9. Shall have an LED display independently showing the status of activity on the communication bus, and processor operation.
10. Optional field installed BACnet® plug-in communication card which includes an EIA-485 protocol communication port, or an optional field installed LonWorks™ plug-in communications card.
11. Software upgrades will be accomplished by local download. Software upgrades through chip replacements are not allowed.
12. Shall be shock resistant in all planes to 5G peak, 11ms during operation, and 100G peak, 11ms during storage.
13. Shall be vibration resistant in all planes to 1.5G @ 20-300 Hz.
14. Shall support a bus length of 4000 ft max, 60 devices per 1000 ft section, and 1 RS-485 repeater per 1000 ft sections.
15. Unit shall be compatible with a programmable 24 volt thermostat.
16. Unit shall be compatible with a zone sensor and a mechanical or solid state time clock connected to the RTU-C.

23 9 23.00.B. Open protocol, direct digital controller:

1. Shall be ASHRAE 62-2001 compliant.
2. Shall accept 18-30VAC, 50-60Hz, and consumer 15VA or less power.
3. Shall have an operating temperature range from -40°F (-40°C) to 125°F (52°C), 10% - 90% RH (non-condensing).
4. Shall have either a field installed BACnet® plug-in communication card which includes an EIA-485 protocol communication port, or a field installed LonWorks™ plug-in communications card.
5. The BACnet® plug in communication card shall include built-in protocol for BACNET (MS/TP and PTP modes).
6. The LonWorks™ plug in communication card shall include the Echelon processor required for all Lon applications.
7. Shall allow access of up to 62 network variables (SNVT). Shall be compatible with all open controllers.
8. Baud rate Controller shall be selectable through the EIA-485 protocol communication port.
9. Shall have an LED display independently showing the status of serial communication, running, errors, power, all digital outputs, and all analog inputs.
10. Shall accept the following inputs: space temperature, setpoint adjustment, outdoor air temperature, indoor air quality, outdoor air enthalpy, compressor lock-out, fire shutdown, enthalpy switch, and fan status/filter status/ humidity/ remote occupancy.
11. Shall provide the following outputs: economizer, fan, cooling stage 1, cooling stage 2, heat stage 1, heat stage 2, exhaust.
12. Software upgrades will be accomplished by either local or remote download. No software upgrades through chip replacements are allowed.
13. Shall be natively equipped with Modbus.

23 09 33 Electric and Electronic Control System for HVAC

23 09 33.00.A. General:

1. Unit shall include a self-contained low-voltage control circuit protected by a fuse on the 24-V transformer side with a reset-table circuit breaker.
2. Shall utilize color-coded wiring.
3. Shall include a central control terminal board to conveniently and safely provide connection points for vital control functions such as: smoke detectors, phase monitor, economizer, thermostat, DDC control options, loss of charge, freeze sensor, high pressure switches.
4. The heat exchanger shall be controlled by the unit control board microprocessor. See heat exchanger section of this specification.
5. Unit shall include a minimum of one 8-pin screw terminal connection board for connection of control wiring.
6. Unit control board shall be provided with 7 segment readout via LCD display for status and diagnostics.
7. Unit control board shall be capable of upstaging heating with use of a single-stage thermostat.

23 09 33.00.B. Safeties:

1. Compressor over-temperature, over current.
2. Standard Low-pressure switch.
 - a. Units shall have low pressure, loss of charge automatic reset device that will shut off compressor when tripped.
 - b. Low pressure control:
 - Provides active protection in both heating and cooling modes at all outdoor ambient temperatures. The low pressure control is an automatic reset type and opens at approximately 15 psig and closes at approximately 40 psig. Operation is slightly different between cooling and heating modes.
3. Standard High-pressure switch.
 - a. Unit shall be equipped with high pressure switch device that will shut off compressor when tripped.
 - b. High Pressure control:
 - The high pressure control is an automatic reset type and opens at approximately 610 psig and closes at approximately 420 psig. The compressor and fan motor will stop when the high pressure control opens and will start again if the high side pressure drops to approximately 420 psig where the automatic reset high pressure control resets. If the high pressure control opens 3 times within a particular call for heating or cooling operation, the defrost control will lock out compressor and outdoor fan operation.
4. Freeze protection sensor is standard on DDC models, and available as an option on Non-DDC models.
5. Automatic reset, motor thermal overload protector.
6. Heating section shall be provided with the following minimum protections:
 - a. High-temperature limit switches.
 - b. Induced draft motor pressure switch.
 - c. Flame rollout switch.
 - d. Flame proving controls.

23 09 93 Sequence of Operations for HVAC Controls

23 09 93.00 INSERT SEQUENCE OF OPERATION

23 40 13 Panel Air Filters

23 41 13.00.A. Standard filter section shall:

1. Consist of factory-installed, low velocity, throwaway 2-in. thick fiberglass filters of commercially available sizes.
2. Unit will accept only 2-in. filters.
3. Filter face velocity shall not exceed 465 fpm at nominal airflows.
4. Filters shall be accessible through an access panel as described in the unit cabinet of the specification (23 81 19.13.H).

23 81 19 Self-Contained Air Conditioners

23 81 19.13 Small Capacity Self-Contained Air Conditioners

23 81 19.13.A. General

1. Outdoor, rooftop mounted, electrically controlled, heating and cooling unit utilizing two hermetic scroll compressors for cooling duty and gas combustion for heating duty.
2. Factory assembled, single-piece heating and cooling rooftop unit. Contained within the unit enclosure shall be all factory wiring, piping, controls, and special features required prior to field start-up.
3. Unit shall use environmentally safe, R410A refrigerant.
4. Unit shall be installed in accordance with the manufacturer's instructions.
5. Unit must be selected and installed in compliance with local, state, and federal codes.
6. Model and serial data shall be reprinted inside the control box.

23 81 19.13.B. Quality Assurance

1. Unit meets ASHRAE 90.1-2019 minimum efficiency requirements.
2. Unit shall be rated in accordance with AHRI Standards 340/360.
3. Unit shall be designed to conform to ASHRAE 15.
4. Unit shall be UL-tested and certified in accordance with ANSI Z21.47 Standards and UL-listed and certified under Canadian standards as a total package for safety requirements.
5. Insulation and adhesive shall meet NFPA 90A requirements for flame spread and smoke generation.
6. Unit casing shall be capable of withstanding Federal Test Method Standard No. 141 (Method 6061) 500-hour salt spray.
7. Unit shall be designed in accordance with ISO 9001:2015, and shall be manufactured in a facility registered by ISO 9001:2015.
8. Roof curb shall be designed to conform to NRCA Standards.
9. Unit shall be subjected to an automated run test on the assembly line. The data for each unit will be stored at the factory, and must be available upon request.
10. Unit shall be designed in accordance with UL Standard 1995, Fifth Ed. including tested to withstand rain.
11. Twenty (20) years for 3 phase, commercial applications stainless steel heat exchanger.
12. One (1) year warranty for 3 phase, commercial application parts.

23 81 19.13.C. Delivery, Storage, and Handling

1. Unit shall be stored and handled per manufacturer's recommendations.
2. Lifted by crane requires either shipping top panel or spreader bars.
3. Unit shall only be stored or positioned in the upright position.
4. Plastic bumpers for handling and protection of unit during transportation and storage.

23 81 19.13.E. Project Conditions

1. As specified in the contract.

23 81 19.13.F. Operating Characteristics

1. Unit shall be capable of starting and running at 115°F (46°C) ambient outdoor temperature, meeting maximum load criteria of AHRI Standard 340/360 at ± 10% voltage.
2. Compressor with standard controls shall be capable of operation down to 50°F (10°C), ambient outdoor temperatures. Low ambient accessory kit is necessary if mechanically cooling at ambient temperatures to 0°F (-17.7°C).
3. Unit shall discharge supply air vertically or horizontally as shown on contract drawings.
4. Unit shall be shipped with both horizontal and vertical openings covered with insulated panels.
5. Unit shall be field convertible from vertical to horizontal configuration.
6. Unit shall have two vertical return openings to accommodate multiple curb configuration options [only one shall be utilized].

23 81 19.13.G. Electrical Requirements

1. Main power supply voltage, phase, and frequency must match those required by the manufacturer.

23 81 19.13.H. Unit Cabinet

1. Unit cabinet shall be constructed of galvanized steel G90.
2. Unit cabinet exterior paint shall be: topcoat primer and paint .20 and .70 MIL dry fill thickness.
3. The sheet-metal cabinet shall be constructed of 18-gauge material for structural components with an underlying coat of G90.
4. Evaporator fan compartment interior cabinet insulation shall conform to AHRI Standards 360 minimum exterior sweat criteria. Interior surfaces shall be insulated with a minimum 1/2-in. thick, 1.6 lb density, flexible fiberglass insulation, foil faced on the air side. Aluminum foil-faced fiberglass insulation shall be used in the gas heat compartment.
5. Shall utilize uniform screw sizing.
6. Base of unit shall have a location for thru-the-base gas and electrical connections standard.
7. Base Rail
 - a. Unit shall have base rails on a minimum of 4 sides.
 - b. Holes shall be provided in the base rails for rigging shackles to facilitate maneuvering and overhead rigging.
 - c. Holes shall be provided in the base rail for moving the rooftop for fork truck.
 - d. Base rail shall be a minimum of 14 gauge thickness.
8. Condensate pan and connections:
 - a. Shall be a sloped condensate drain pan made of a non-corrosive material and be removable for cleaning.
 - b. Shall comply with ASHRAE Standard 62.
 - c. Shall use a 1" NPT drain connection, possible either through the bottom or side of the drain pan. Connection shall be made per manufacturer's recommendations.
 - d. Shall be able to slide out completely.
 - e. Shall be separate from the coil.
9. Standard factory installed condensate overflow sensor.
10. Top panel:
 - a. Shall be a single piece top panel over indoor section.
11. Gas Connections:
 - a. All gas piping connecting to unit gas valve shall enter the unit cabinet at a single location on side of unit (horizontal plane).
 - b. Thru-the-base capability
 - i. Standard unit shall have a thru-the-base gas-line location using a continuous raised, flange around opening in the basepan.
 - ii. No basepan penetration, other than those authorized by the manufacturer, is permitted.
12. Electrical Connections
 - a. All unit power wiring shall enter unit cabinet a single, factory-prepared, continuous raised flange opening in the basepan.
 - b. Thru-the-base capability
 - i. Standard unit shall have a thru-the-base electrical location(s) using a raised, continuous raised flange opening in the basepan.
 - ii. No basepan penetration, other than those authorized by the manufacturer, is permitted.
 - c. Factory standard phase-monitor on Non-DDC models and optional on DDC models.
13. Component access panels (standard)
 - a. Cabinet panels shall be easily opened for servicing.
 - b. Stainless steel metal hinges are optional on all doors.
 - c. Panels covering control box, indoor fan, indoor fan motor, gas components (where applicable), and filters shall have hinges with 1/4 turn fasteners on units with factory-installed hinged option.

23 81 19.13.I. Gas Heat

1. General
 - a. Shall have standard two stage gas heat
 - b. Heat exchanger shall be an induced draft design. Positive pressure heat exchanger designs shall not be allowed.
 - c. Shall incorporate a direct-spark ignition system and redundant main gas valve.
 - d. Heat exchanger design shall allow combustion process condensate to gravity drain; maintenance to drain the gas heat exchanger shall not be required.
 - e. Gas supply pressure at the inlet to the rooftop unit gas valve must match that required by the manufacturer.

- f. The heat exchanger shall be controlled by the Core Command microprocessor.
 - g. The Core Command board shall notify users of fault using two 7 segment displays.
 - h. Heat exchanger shall be removable via slide out rails.
2. Standard Heat Exchanger construction
- a. Heat exchanger shall be of the tubular-section type constructed of a minimum of 20-gauge steel coated with a nominal 1.2 mil aluminum-silicone alloy for corrosion resistance.
 - b. Use energy saving, direct-spark ignition system.
 - c. Use a redundant main gas valve.
 - d. Burners shall be of the in-shot type constructed of aluminum-coated steel.
 - e. Burners shall incorporate orifice for rated heat output up to 2,000 ft. (610m) elevation with a gas heating value of 1050. Alternate orifices may be required depending on local gas heating values and elevations.
 - f. Each heat exchanger tube shall contain restrictions similar to dimples for more effective heat transfer.
3. Optional Stainless Steel Heat Exchanger construction
- a. Use energy saving, direct-spark ignition system.
 - b. Use a redundant main gas valve.
 - c. Burners shall be of the in-shot type constructed of aluminum-coated steel.
 - d. Gas piping may enter the unit cabinet at a single location on side of unit (horizontal plane).
 - e. The optional stainless steel heat exchanger shall be of the tubular-section type, constructed of a minimum of 20-gauge type 409 stainless steel.
 - f. Type 409 stainless steel shall be used in heat exchanger tubes.
4. Induced draft combustion motor and blower
- a. Shall be a direct-drive, single inlet, forward-curved centrifugal type.
 - b. Shall be made from steel with a corrosion-resistant finish.
 - c. Shall be permanently lubricated sealed bearings.
 - d. Shall have inherent thermal overload protection.
 - e. Shall have an automatic reset feature.

23 81 19.13.J. Coils

1. Standard Aluminum/MicroChannel Coils:
- a. Standard evaporator and condenser coils shall be aluminum.
 - b. MicroChannel intertwined coils for both evaporator and condenser coils.
 - c. Evaporator and condenser coils shall be leak tested to 150 psig, pressure tested to 400 psig, and qualified to burst test at 1,800 psi.

23 81 19.13.K. Refrigerant Components

1. Refrigerant circuit shall include the following control, safety, and maintenance features:
- a. TXV metering system shall prevent mal-distribution of two-phase refrigerant.
 - b. Thermal Expansion Valve (TXV).
 - c. Refrigerant filter drier.
 - d. Service gauge connections on suction, liquid and discharge lines.
 - e. Access panels can be removed without disrupting condenser air flow.
2. Compressors
- a. Unit shall use two fully hermetic scroll compressor.
 - b. Compressor motors shall be cooled by refrigerant gas passing through motor windings.
 - c. Compressors shall be internally protected from high discharge temperature conditions.
 - d. Compressors shall be protected from an over-temperature and over-ampereage conditions by an internal, motor overload device.
 - e. Compressor shall be factory mounted on rubber grommets.
 - f. Compressor motors shall have internal line break thermal and current overload and high pressure differential protection.
 - g. Crankcase heaters shall not be required for normal operating range.
 - h. Compressor lockout sensor on the unit controller is factory set at 35°F and is adjustable from 30°F (-1°C) to 50°F (10°C) and resets the cooling lockout at 5°F (+2.7°C) above the set point.

23 81 19.13.L. Filter Section

1. Filters access is specified in the unit cabinet section of this specification.
2. Filters shall be held in place by metal rods, facilitating easy removal and installation.
3. Shall consist of factory-installed, low velocity, throw-away 2-in. thick fiberglass filters.
4. Filter face velocity shall not exceed 465 fpm at nominal airflows.
5. Filters shall be standard, commercially available sizes.
6. Only one size filter per unit is allowed.

23 81 19.13.M. Evaporator Fan and Motor

1. Evaporator fan motor:
 - a. Shall have permanently lubricated bearings.
 - b. Shall have inherent automatic-reset thermal overload protection.
 - c. Shall have a maximum continuous bhp rating for continuous duty operation; no safety factors above that rating shall be required.
2. Belt-Driven Evaporator Fan:
 - a. Belt drive shall include an adjustable-pitch motor pulley.
 - b. Shall use sealed, permanently lubricated ball-bearing type.
 - c. Blower fan shall be double-inlet type with forward curved blades.
 - d. Shall be constructed from steel with a corrosion resistant finish and dynamically balanced.
3. Blower Assembly
 - a. Entire assembly shall be able to slide out completely including VFD, two blowers, and motor.
 - b. Shall be able to slide-out without the removal of the roof and condenser fan motors.

23 81 19.13.N. Condenser Fans and Motors

- a. Shall be a totally enclosed motor.
- b. Shall use permanently lubricated bearings.
- c. Shall have inherent thermal overload protection with an automatic reset feature.
- d. Shall use a shaft-up design.
2. Condenser Fans shall:
 - a. Shall be a direct-driven propeller type fan.
 - b. Shall have blades riveted to corrosion-resistant steel spiders and shall be dynamically balanced.

23 81 19.13.O. Special Features

1. Integrated Economizers:
 - a. Integrated, gear-driven parallel modulating blade design type capable of simultaneous economizer and compressor operation.
 - b. Independent modules for vertical or horizontal return configurations shall be available. Vertical return modules shall be available as a factory installed option.
 - c. Damper blades shall be galvanized steel with metal gears. Plastic or composite blades on intake or return shall not be acceptable.
 - d. Shall include all hardware and controls to provide free cooling with outdoor air when temperature and/or humidity are below setpoints.
 - e. Shall be equipped with gear driven dampers for both the outdoor ventilation air and the return air for positive air stream control.
 - f. Shall be equipped with low-leakage dampers, not to exceed 2% leakage at 1 in. wg pressure differential.
 - g. Shall be capable of introducing up to 100% outdoor air.
 - h. Shall be equipped with a barometric relief damper capable of relieving up to 35% return air, depending on the airflow.
 - i. Shall be designed to close damper(s) during loss-of-power situations with spring return built into motor.
 - j. Enthalpy sensor shall be provided as standard. Outdoor air sensor set point shall be adjustable and shall range from 40°F to 100°F / 4°C to 38°C. Additional sensor options shall be available as accessories.
 - k. The economizer controller shall also provide control of an accessory power exhaust unit function. Factory set at 70%, with a range of 0% to 100%.
 - l. The economizer shall maintain minimum airflow into the building during occupied period and provide design ventilation rate for full occupancy. A remote potentiometer may be used to override the damper set point.
 - m. Dampers shall be completely closed when the unit is in the unoccupied mode.
 - n. Economizer controller shall accept a 2-10Vdc CO₂ sensor input for IAQ/DCV control. In this mode, dampers shall modulate the outdoor-air damper to provide ventilation based on the sensor input.

- o. Actuator shall be directly coupled to economizer gear. No linkage arms or control rods shall be acceptable.
 - p. Economizer controller shall provide indications when in free cooling mode, in the DCV mode, or the exhaust fan contact is closed.
 - q. Economizer wire harness will have provision for smoke detector available in supply and return options.
2. Manual damper
- a. Manual damper package shall consist of damper, air inlet screen, and rain hood which can be preset to admit up to 50% outdoor air for year-round ventilation.
3. Two-Position Motorized Damper
- a. Damper shall be a Two-Position Motorized Damper. Damper travel shall be from the full closed position to the field adjustable %-open setpoint.
 - b. Damper shall include adjustable damper travel from 25% to 100% (full open).
 - c. Damper shall include single or dual blade, gear driven dampers and actuator motor.
 - d. Actuator shall be direct coupled to damper gear. No linkage arms or control rods shall be acceptable.
 - e. Damper will admit up to 100% outdoor air for applicable rooftop units.
 - f. Damper shall close upon indoor (evaporator) fan shutoff and/or loss of power.
 - g. The damper actuator shall plug into the rooftop unit's wiring harness plug. No hard wiring shall be required.
 - h. Outside air hood shall include aluminum water entrainment filter.
4. Liquid Propane (LP) Conversion Kit (sold separately)
- a. Kit shall contain all the necessary hardware and instructions to convert a standard natural gas unit for use with liquefied propane, up to 2000 ft (610m) elevation.
5. Condenser Coil Hail Guard Assembly
- a. Shall protect against damage from hail.
 - b. Shall be louvered style.
6. Unit-Mounted, Non-Fused Disconnect Switch:
- a. Switch shall be factory or field installed.
 - b. Switch shall be internally mounted with external access.
 - c. National Electric Code (NEC) and UL approved non-fused switch shall provide unit power shutoff.
 - d. Shall be accessible from outside the unit.
 - e. Shall provide local shutdown and lockout capability.
7. Convenience Outlet:
- a. Optional Non-Powered convenience outlet.
 - b. Optional Powered convenience outlet.
 - c. Outlet shall be powered from a separate 115-120v power source.
 - d. A transformer shall not be included.
 - e. Outlet shall be field-installed and internally mounted with easily accessible 115-v female receptacle.
 - f. Outlet shall include 15 amp GFI receptacle with independent fuse protection.
 - g. Outlet shall be accessible from outside the unit.
8. Flue Diverter:
- a. Flue discharge shall direct unit exhaust horizontally and have the capability of being directed vertically.
 - b. Deflector shall be defined as a "natural draft" device by the National Fuel and Gas (NFG) code.
9. Propeller Power Exhaust:
- a. Power exhaust shall be used in conjunction with an integrated economizer.
 - b. Configurable for vertical and horizontal installation.
 - c. Horizontal power exhaust is shall be mounted in return ductwork.
 - d. Power exhaust shall be controlled by economizer controller operation. Exhaust fans shall be energized when dampers open past the 0-100% adjustable setpoint on the economizer control.
 - e. Capable of constant volume.
10. Roof Curbs (Vertical):
- a. Formed galvanized steel with wood nailer strip and shall be capable of supporting entire unit weight.
 - b. Permits installation and securing of ductwork to curb prior to mounting unit on the curb.
 - c. Shall be available in heights of 14", 18", and 24".

11. Outdoor Air Enthalpy Sensor:
 - a. The outdoor air enthalpy sensor shall be used to provide single enthalpy control. When used in conjunction with a return air enthalpy sensor, the unit will provide differential enthalpy control. The sensor allows the unit to determine if outside air is suitable for free cooling.
12. Universal Gas Conversion Kit:
 - a. Package shall contain all the necessary hardware and instructions to convert a standard natural gas unit to operate from 2000-7000 ft (610 to 2134m) elevation with natural gas or from 0-7000 ft (90-2134m) elevation with liquefied propane.
13. Return Air Enthalpy Sensor:
 - a. The return air enthalpy sensor shall be used in conjunction with an outdoor air enthalpy sensor to provide differential enthalpy control.
14. Indoor Air Quality (CO2) Sensor:
 - a. Shall be able to provide demand ventilation indoor air quality (IAQ) control.
 - b. The IAQ sensor shall be available in duct mount, wall mount, or wall mount with LED display. The set point shall have adjustment capability.
15. Smoke detectors:
 - a. Shall be a Four-Wire Controller and Detector.
 - b. Shall be environmental compensated with differential sensing for reliable, stable, and drift-free sensitivity.
 - c. Shall use magnet-activated test/reset sensor switches.
 - d. Shall have tool-less connection terminal access.
 - e. Shall have a recessed momentary switch for testing and resetting the detector.
 - f. Controller shall include:
 - One set of normally open alarm initiation contacts for connection to an initiating device circuit on a fire alarm control panel.
 - Two Form-C auxiliary alarm relays for interface with rooftop unit or other equipment
 - One Form-C supervision (trouble) relay to control the operation of the Trouble LED on a remote test/reset station
 - Capable of direct connection to two individual detector modules.
 - Can be wired to up to 14 other duct smoke detectors for multiple fan shutdown applications.

26 29 23.12. Adjustable Frequency Drive

1. Unit shall be supplied with an electronic variable frequency drive for the supply air fan.
2. Drive shall be factory installed in an enclosed cabinet.
3. Drive shall meet UL Standard 95-5V.
4. The completed unit assembly shall be UL listed.
5. Drives are to be accessible through an access panel (optional hinged doors).
6. The unit manufacturer shall install all power and control wiring.
7. The supply air fan drive output shall be controlled by the factory installed main unit control system and drive status and operating speed shall be monitored and displayed at the blower.
8. Drive shall be programmed and factory run tested in the unit.
9. VFD shall be modular and designed for easy disconnect via wiring harness

BEFORE PURCHASING THIS APPLIANCE, READ IMPORTANT ENERGY COST AND EFFICIENCY INFORMATION AVAILABLE FROM YOUR RETAILER.

GENERAL TERMS OF LIMITED WARRANTY*

Ruud will furnish a replacement for any part of this product which fails in normal use and service within the applicable periods stated, in accordance with the terms of the limited warranty.

*For complete details of the Limited and Conditional Warranties, including applicable terms and conditions, contact your local contractor or the Manufacturer for a copy of the product warranty certificate.

Compressor

3 Phase, Commercial ApplicationsFive (5) Years

Stainless Steel Heat Exchanger

3 Phase, Commercial ApplicationsTwenty (20) Years

Factory Standard Heat Exchanger

3 Phase, Commercial ApplicationsTen (10) Years

Parts

3 Phase, Commercial ApplicationsOne (1) Year



Before proceeding with installation, refer to installation instructions packaged with each model, as well as complying with all Federal, State, Provincial, and Local codes, regulations, and practices.

© 2023 Rheem Manufacturing Company. Ruud trademarks owned by Rheem Manufacturing Company.

In keeping with its policy of continuous progress and product improvement, Ruud reserves the right to make changes without notice.

Ruud Heating, Cooling & Water Heating • 5600 Old Greenwood Road
Fort Smith, Arkansas 72908 • www.ruud.com

Ruud Canada • 125 Edgeware Road, Unit 1
Brampton, Ontario • L6Y 0P5

RELY ON RUUD.™

PRINTED IN U.S.A. 3/22 QG FORM NO. R22-874