

## DX SERIES - ALUMINUM DEDICATED HORIZONTAL COIL



### 1. Safety Instruction

Potential safety hazards are alerted using the following symbols. The symbol is used in conjunction with terms that indicate the intensity of the hazard.



#### WARNING

This symbol indicates a potentially hazardous situation, which if not avoided, could result in serious injury, property damage, product damage or death.



#### CAUTION

This symbol indicates a potentially hazardous situation, which if not avoided, may result in moderate injury or property damage.



#### WARNING

Product designed and manufactured to permit installation in accordance with local and national building codes. It is the installer's responsibility to ensure that product is installed in strict compliance with national and local codes. Manufacturer takes no responsibility for damage (personal, product or property) caused due to installations violating regulations.



#### WARNING

Certified technicians or those individuals meeting the requirements specified by NATE may use this information. Property and product damage or personal injury hazard may occur without such background.



#### WARNING

All power sources should be disconnected prior to servicing. Failure to do so may cause personal injury or property damage.



#### WARNING

As expressed in our product warranty; **ASPEN WILL NOT BE BILLED FOR ANY STRUCTURAL DAMAGES CAUSED BY FAILURE TO FOLLOW THIS INSTALLATION REQUIREMENT.** The drains from the auxiliary drain pan must be installed according to the local building codes.



#### CAUTION

Drain lines from the auxiliary drain pan should **NOT** be connected to the primary drain line of the coil.

✓ Install coils with the drain pan and/or casing on a flat, level surface. Slope the coil 1/4" towards the drain. Condensate lines must be installed in accordance with building codes. It is the contractor's responsibility to ensure proper condensate drainage at the time of the installation; Aspen bears no responsibility for damages caused by improper condensate management.



#### CAUTION

Some coils have primary and secondary drain ports on both sides of the pan to offer installation flexibility, so ensure all threaded plugs are in present and tightened in any unused drain ports. These may be hidden behind the coil casing access door. Failure to do so may result in property water damage; it is the contractor's responsibility to ensure these plugs are present and tight.

✓ The drain lines must be installed with 1/4" per foot pitch to provide free drainage. A condensate trap **MUST** be installed on the primary drain line to ensure proper drainage of the condensate. The trap must be installed in the drain line below the bottom of the drain pan. Fig. 4-1 illustrates the typical drain trap installation. Prior to installation, ensure drain pan hole is not obstructed. Additionally, Aspen recommends the drain lines be insulated to prevent sweating and dripping.

### 2. Inspection

✓ On receiving the product, visually inspect it for any major shipping related damages. Shipping damages are the carrier's responsibility. Inspect the product labels to verify the model number and options are in accordance with your order. Manufacturer will not accept damage claims for incorrectly shipped product.

### 3. Installation Preparation

✓ Read all the instructions in this guideline carefully while paying special attention to the WARNING and CAUTION alerts. If any of the instructions are unclear, clarify with a certified technician before proceeding. Gather all tools needed for successful installation of the unit prior to beginning the installation. **Note that absence of pressure/charge does not verify a leak. Check coils for leaks prior to installation.**

### 4. Condensate Drain Preparation

✓ DX coils are designed with a built in Primary drain pan only. Please Check local building codes for auxiliary drain pan requirements. The auxiliary drain pan must have a separate drain line that is properly sloped and terminated in an area visible to the home owner. The auxiliary pans provide extra protection to the area under the unit should the primary and secondary drain plug up and overflow.

Fig 4-1. Typical drain line trap set up

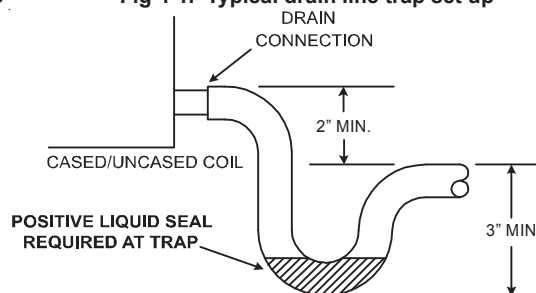

✓ The drain pan has primary (white) and secondary (red) drain connections. If a secondary drain line is required, it should be run separately from the primary and should terminate in a highly visible location. Condensate disposal through the secondary drain line indicates that the primary drain line is plugged and needs cleaning. If a secondary drain line will not be provided, plug the secondary drain. Drain plugs are NOT to be reused without plumbers tape or putty. Drain line connection should be finger tightened, then turned no more than one complete turn as needed to ensure a firm connection. DO NOT overtighten connection or damage may occur.

## 5. Coil Installation



### WARNING

The coil is manufactured with dry nitrogen pre-charge. Release the pressure through the Schrader valve test port prior to installation. If holding pressure is not present, return coil to distributor for exchange.

✓ Clean coil fins with degreasing agent or mild detergent and rinse fins clean prior to installation.

✓ The refrigerant line sizes should be selected according to the recommendations of the outdoor unit manufacturer.

✓ Care must be taken to ensure all connection joints are burr-free and clean. Failure to do so may increase chances of a leak. It is recommended to use a pipe cutter to remove the spun closed end of the suction line.

✓ To reduce air leakage, rubber grommets may be present where the lines pass through the coil case. To avoid damage, remove grommets prior to brazing by sliding over the lines. Use a quenching cloth or allow the lines to cool before reinstalling the grommets.

✓ Use of wet rags/quenching cloth is highly recommended to prevent weld-related damages to the casing and Schrader valve (if present).



### CAUTION

Coil should be installed on the discharge side of the furnace



### CAUTION

Some Aspen coils may include a Schrader valve on the suction manifold. Ensure that the Schrader valve and valve core (where present) are protected from heat to prevent leakage.

### 5A. Horizontal Only Installation

A dual drain pan (pan within a pan) is used for condensate collection. Condensate drain ports are located on both left and right sides of the unit.

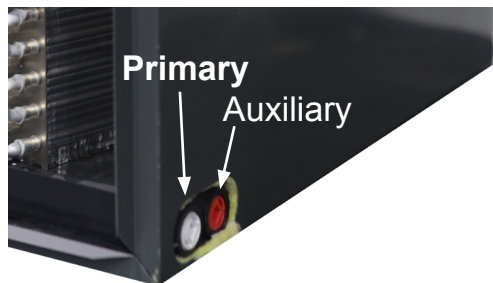

A condensate trap, as shown MUST be installed on the primary drain line to ensure proper drainage of the condensate. Drain lines should maintain a 1/4" per foot drop for proper condensate drain flow.



### CAUTION

Duct work must be installed in accordance with the local building codes. Aspen will not be liable for damages caused due by nonconformance to local building codes.



### Airflow Direction

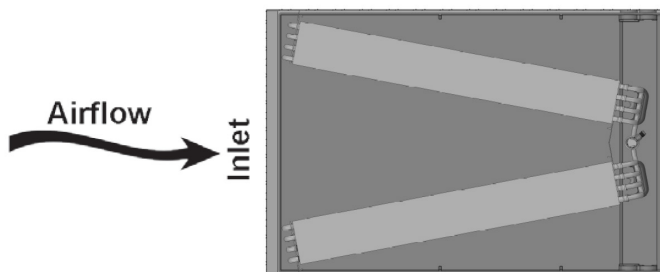

Airflow enters through the inlet of the coil and exits at the outlet, entering the interior of the enclosure for routing to the attached ductwork.

### 5B. Horizontal Orientation

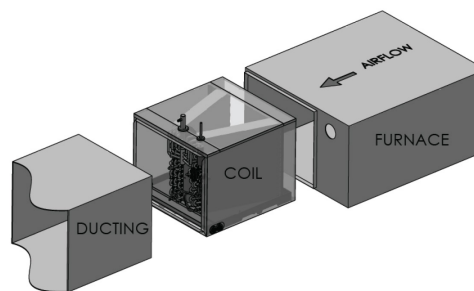

Fig 5B-1. Horizontal Left Application

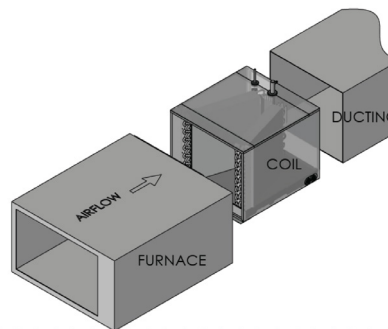

Fig 5B-2. Horizontal Right Application

Refer to Furnace/Air Handler manufacturer literature for specific coil installation guidelines and recommendations.

## 6. Suction Line Connection



**WARNING** The sensing bulb and TXV body **MUST** be protected from overheating during brazing. The sensing bulb and TXV body must be covered using a quench cloth or wet cloth when brazing. Pointing the brazing flame away from the valve and sensing bulb provide partial protection only.



**CAUTION** Some Aspen coils may include a Schrader valve on the suction manifold. Ensure that the Schrader valve and valve core (where present) are protected from heat to prevent leakage.

1. Ensure suction line connection joints are burr-free and clean. Failure to do so may increase chances of a leak and introduce contaminants to the system. It is recommended to use a pipe cutter to remove the spun closed end of the suction line.

2. Swedge (or use a field supplied coupler) and braze the field supplied refrigerant suction line tubing to the coil stub using approved industry practices.



**WARNING** Do not attempt to touch brazed joints while hot. Severe burns may result.

## 7. Metering Devices/Liquid Line Connection

Aspen coils are available with two kinds of metering devices a) flowrator or b) TXV. The following instructions are separated into sections by metering device.

### 7A. Flowrator Coils

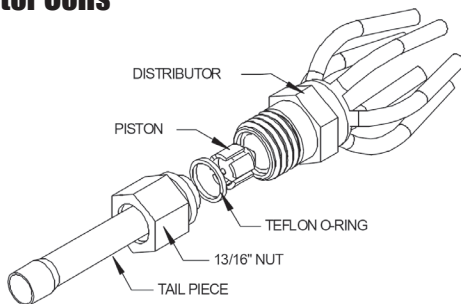

Fig 7A-1. Flowrator assembly components



**CAUTION** Use Piston sizes recommended by the outdoor unit manufacturer whenever possible. The piston should be sized according to the capacity of the outdoor unit.



**WARNING** Failure to install the proper piston can lead to poor system performance and possible compressor damage.

## I. Installation

Note: Photos are for basic illustration purposes only. Actual equipment configuration may differ from that shown.

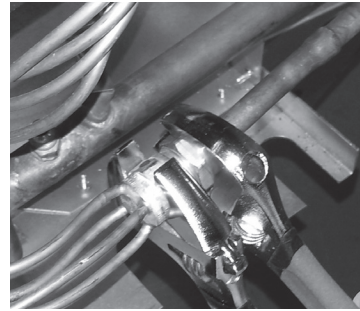

I-1. Disassemble flowrator body using two wrenches and unscrewing with a counterclockwise motion.

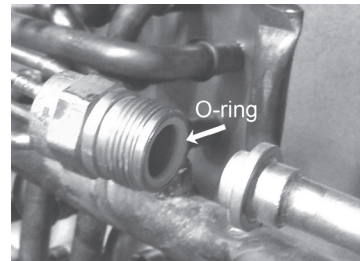

I-2. Replace the Teflon O-ring (located between the halves). Discard Schrader if present.



**CAUTION** Be aware of the Teflon O-ring. Be sure to replace the O-ring to attain a proper seal. (The Teflon O-ring is located between the two halves of the flowrator)

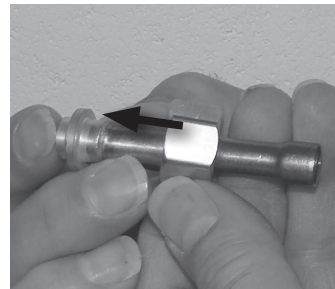

I-3. Slide the attachment nut onto the liquid line stub out.

I-4. Braze the stub-out portion to the liquid line and let cool.

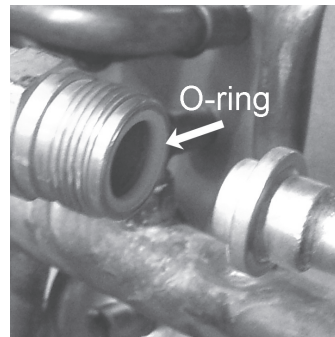

I-5. Taking care that the white Teflon seal is still in place inside the flowrator body, firmly seat the stub and screw the attachment nut to flowrator body.

I-6. Tighten the nut to a torque of approximately 10-30 ft-lbs. **Do NOT overtighten the nut.** Overtightening will impede the piston movement during operation.

## II. Piston Replacement

Note: Photos are for basic illustration purposes only. Actual equipment configuration may differ from that shown.

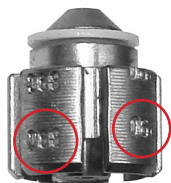

Fig 7A-2

During some installations, a piston change may be required. If so, the installer **MUST** change the piston. Use piston sizes recommended by the outdoor unit manufacturer. If a sizing chart is not available, use the piston size chart provided below to size the required piston. The size of the piston is stamped on the piston body (Fig 7A-2).

Use the chart below when matching coil with an outdoor unit with a different nominal capacity than the coil.

Outdoor Unit Capacity	R22 Orifice Size	R410a Orifice Size
12,000	0.041	N/A
18,000	0.055	0.049
24,000	0.059	0.055
30,000	0.068	0.059
36,000	0.074	0.068
42,000	0.080	0.074
48,000	0.084	0.080
60,000	0.092	0.089

**II-1.** Evacuate the system as per manufacturer guidelines and recommendations

**II-2.** Turn the 13/16" nut once to release any residual pressure in the coil.



**II-3.** After ensuring that the coil is free of any residual pressure, disassemble the flowrator body completely using two wrenches. Take great care not to distort the feeder tubes. The wrench used to clasp the nut should be turned in counter-clockwise direction to unscrew the nut.



**II-4.** Slide the 13/16" nut over the lineset and separate the two halves of the flowrator.

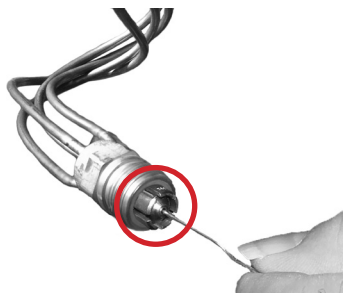

**II-5.** Pull the piston out using a small wire or pick. Verify the piston size (size is typically stamped on the body of the piston - Fig 7A-2). If a different piston size is required by the outdoor unit manufacturer, replace the piston using the small wire provided with the piston kit.



**II-6.** Replace the piston with one of the correct size. Do not force the new piston into the body. Make sure the piston moves freely in body.



**CAUTION** Pay close attention to the piston orientation. The pointed end of the piston **MUST** go into the distributor body, towards the coil. Failure to ensure this orientation will cause the piston to be bypassed during operation which might damage the outdoor unit.

**II-7.** Assemble the two halves correctly and ensure that the Teflon O-ring is present between the two halves (See I-5). Slide the 13/16" nut onto the distributor body.



**CAUTION** Be aware of the Teflon O-ring. Be sure to replace the O-ring to attain a proper seal. (The Teflon O-ring is located between the two halves of the flowrator)

**II-8.** Tighten the nut to a torque of approximately 10-30 ft-lbs. Do NOT overtighten the nut. Overtightening will impede the piston movement during operation.

**II-9.** If present, slide the rubber grommet back to position to prevent air leakage.

### 7B. TXV Coils

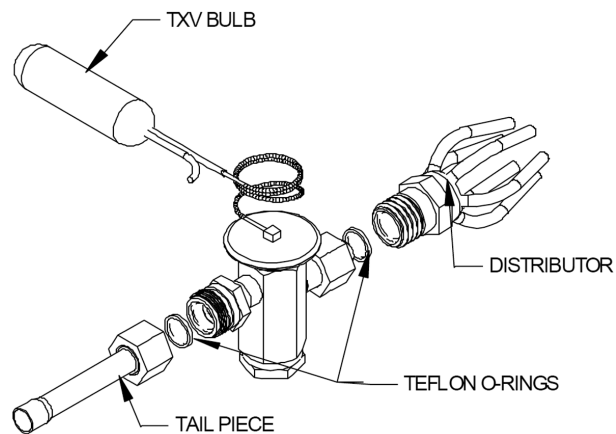

Fig 7B-1. Components of a typical TXV assembly



**WARNING** The sensing bulb and TXV body **MUST** be protected from overheating during brazing. The sensing bulb and TXV body must be covered using a quench cloth or wet cloth when brazing. Pointing the brazing flame away from the valve and sensing bulb provide partial protection only.



**CAUTION** Ensure that the TXV selected is compatible with the refrigerant used in the outdoor system (R22 or R410A). TXV caps are painted green for R22 or pink for R410A. In absence of color, the caps will be marked with the compatible refrigerant.



**CAUTION** The valves should be sized according to the capacity of the outdoor unit. Failure to install the right valve can lead to poor performance and possible compressor damage.

## I. TXV Bulb Horizontal Mounting

The orientation and location of the TXV bulb has a major influence on the system performance.



**CAUTION** Ensure that the TXV bulb is in direct contact with the suction/vapor line. Gap between the bulb and tube should be avoided. Failure to do so will impair the proper functioning of the TXV valve.

It is recommended that the TXV bulb be installed parallel to the ground (on a horizontal plane). The bulb position should be at 2 o'clock or 10 o'clock. Fig. 7B-2 shows the recommended position for the TXV bulb installation in the horizontal plane.

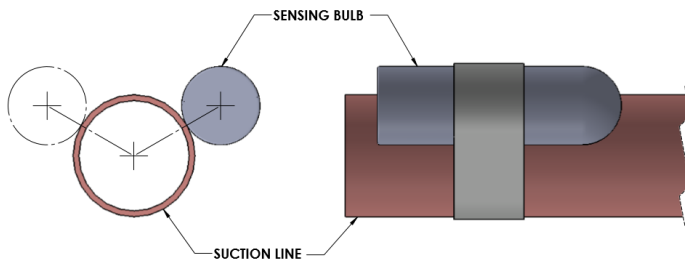

Bulb position at  
2 o'clock or  
10 o'clock

Fig 7B-2. Recommended location for horizontal TXV bulb mount

The TXV sensing bulb **SHOULD** be mounted on the suction line approximately 6" from the TXV or coil housing using the metal clamp provided. In order to obtain a good temperature reading and correct superheat control, the TXV sensing bulb must conform to ALL of the following criteria:

1. The sensing bulb **MUST** be in direct and continuous contact with the suction line.
2. The sensing bulb should be mounted horizontally on the suction line.
3. The sensing bulb **MUST** be mounted at the 2 o'clock or 10 o'clock position on the circumference of the suction line.
4. The sensing bulb **MUST** be insulated from outside air.

A properly mounted sensing bulb will prevent false readings caused by liquid refrigerant that may have formed inside the suction/vapor line. Insulation will protect the sensing bulb from false readings due to contact with warm air.

## II. TXV Bulb Vertical Mounting

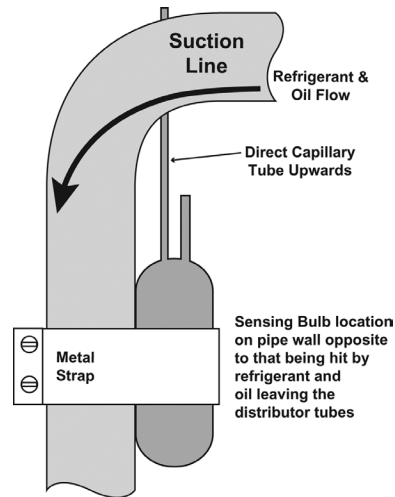

Fig 7B-3. Recommended location for vertical TXV bulb mount

As recommended in Section 7B-1, the TXV sensing bulb should be mounted in a horizontal plane in relation to the suction/vapor line. However, some installation configurations may require that the sensing bulb be mounted vertically. In this instance, place the bulb opposite the piping wall being hit by refrigerant and oil leaving the distributor tubes, and with capillary tubes directed upwards as shown in Fig. 7B-3.



**CAUTION** If the TXV sensing bulb is mounted vertically; the capillary **MUST** be directed upwards. The bulb must be mounted on the wall opposite to that being directly hit by the refrigerant and oil leaving the distributor tubes.

## III. Field-Installed TXV Retrofit

*Note: Photos are for basic illustration purposes only. Actual equipment configuration may differ from that shown.*

When installing an expansion valve, it is not necessary to slide the coil out of the housing.

For disassembly and piston removal refer to section 7A-I.

**III-1.** Inspect the TXV box to confirm that the valve is compatible with the refrigerant in the system.

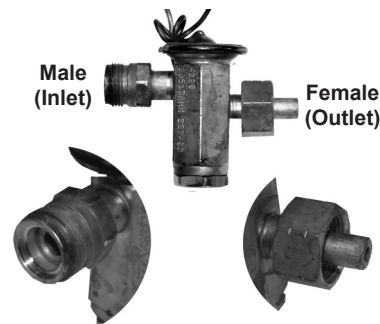

**III-2.** Remove the valve from the box and note the location of the inlet side (threaded male port) and the outlet side (female swivel nut port).



**III-4.** Slide the attachment nut onto the liquid line stub out. (See 7A, I-3)

**III-5.** Braze the stub-out portion to the liquid line and let cool.



**WARNING** Do not attempt to touch brazed joints while hot. Severe burns may result.

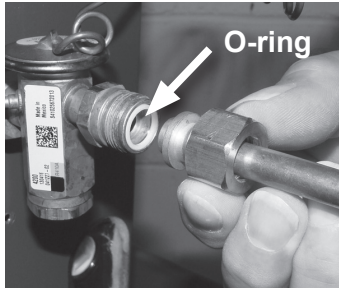

**III-6.** Remove the additional Teflon O-ring seal from the box and place on the shoulder just inside the TXV inlet port. Screw the nut attached to the stub-out portion of the flowrator body onto the inlet port of the TXV.

**III-7.** Tighten all connections taking care to use proper back up.

**III-8.** Remove the valve identification sticker from the valve and place it adjacent to the Aspen model number on unit name plate.

**III-9a.** Some Aspen coils come with a Schrader valve on the suction line. **If a Schrader port is present:**

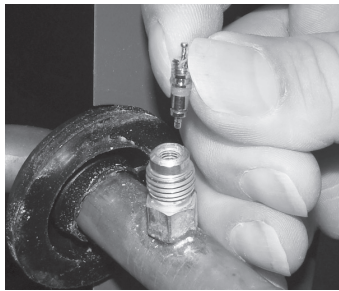

**A.** Remove the valve stem from the Schrader port mounted on the suction line.

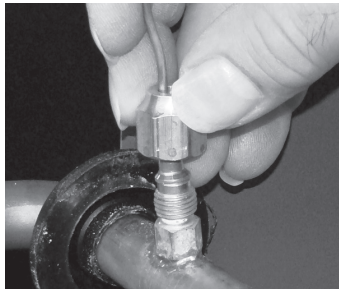

**B.** Screw flare nut on TXV equalization tube on to the Schrader valve stem.

**III-9b.** In some cases, a suction line Schrader port may not be present. **If a Schrader port is NOT present:**



**A.** Install a field-supplied braze-on Schrader valve like that shown on the suction line near the intended sensing bulb mounting location. Follow valve manufacturer instructions and recommendations for installation.

**B.** Attach equalizer tube to valve as described in section III-9a above.

**III-10.** Mount the sensing bulb as described in section 7B-I or 7B-II.



**CAUTION** When handling or manipulating the equalizer tube, take great care not to kink or make extreme bends in the tubing.



**CAUTION** Using a non-bleed expansion valve may require the use of a hard-start kit. Follow the outdoor unit manufacturer's guidelines.

## 8. Connecting Refrigerant Lines

**1.** Release nitrogen holding charge by depressing the Schrader Valve at the suction line connection. If no gas releases from the coil, contact distributor regarding potential leak.

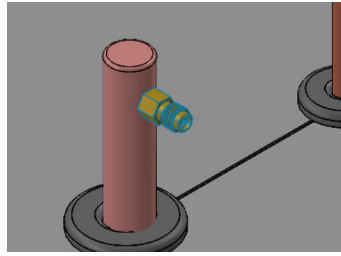

**2.** Cut off Schrader Valve fitting at the suction line connection. Use a tubing cutter for this step. Clean the burr from the cut tubing to reduce the chance of future leaks. Connect the suction line to the tubing at the indoor unit.

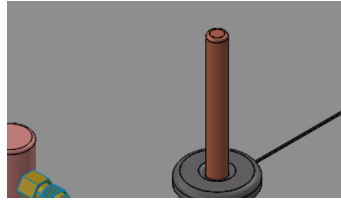

**3.** Use a tubing cutter to remove the spun end from the liquid line connection at the air handler. Clean the burr from the cut tubing to reduce the chance of future leaks.

**4.** To avoid heat damage to grommets where present, remove these prior to brazing by sliding them over the refrigerant lines and out of the way.

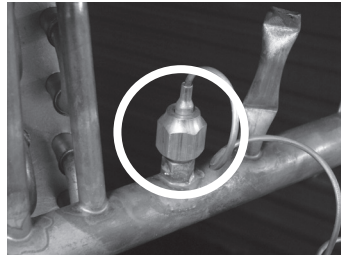

**5.** Check to determine if the evaporator coil has a Schrader fitting on the suction manifold. If yes, remove the valve core to prevent heat damage during brazing. Replace the valve core once the piping has cooled.

**6.** Flow nitrogen through the piping when brazing.

**7.** Braze both refrigerant line connections using proper brazing procedures.

**8.** When all line connections are brazed, perform a proper system evacuation procedure per the outdoor unit manufacturer instructions.

**9.** Seal the penetration openings where the lineset piping enters the cabinet.

## 9. Leak Check

**1.** Following outdoor unit manufacturer instructions and recommendations, charge the system with dry nitrogen to a maximum pressure of 150 PSIG.

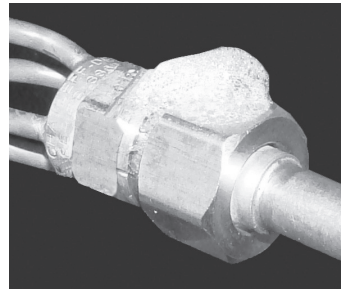

**2.** Check all brazed and screw-on line connections by applying a soap solution to the joint. A leak will produce bubbles in the soap solution.

**3.** If any leaks are discovered, relieve system pressure and repair leaks. Repeat steps 1-3.

**4.** With no leaks or weak connections present, evacuate the system and charge as per the outdoor unit manufacturer instructions and specifications.

## 10. System Charging



**CAUTION** An improperly charged system will likely cause loss in system performance and may damage the compressor.



**CAUTION** Refer to outdoor unit manufacturer charging guidelines and recommendations. The recommendations given below are general in nature and are NOT to supersede outdoor unit manufacturer specifications.

**2A. Flowrator coils:** Add refrigerant until the superheat measured at the outdoor unit suction/vapor line matches the superheat from the chart below.

Outdoor Temp °F D.B.	Superheat		
	Min	Nom	Max
65	30	35	40
70	26	30	34
75	21	25	29
80	17	20	23
85	12	15	18
90	8	10	12
95	4	5	7
100			

**2B. TXV coils:** Add refrigerant until the subcooling measured at the outdoor unit liquid line matches the subcooling recommendation of the outdoor manufacturer. If chart is unavailable charge the unit to a subcooling value of 8°F +/- 1°F.

## 11. Mounting Dedicated Horizontal Coil to Furnace

1. Remove shipping brackets on both ends of coil cabinet. Bracket shown below.



2. Slide coil up to furnace (note: bottom flange on coil cabinet will slide under furnace, flanges on furnace should slide inside coil cabinet) Coil cabinet should be flush to back side of furnace.

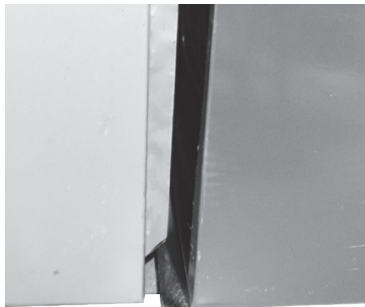

Front Side View

For applications where the coil cabinet is the same height as the furnace use the supplied Z bracket to attach to furnace as shown below.



Top View of Cabinet

For applications where the coil cabinet is taller than the furnace use an L shaped filler bracket to attach to furnace to coil, as shown below. (Bracket is supplied with DX coils with the 8th option code selection -034)

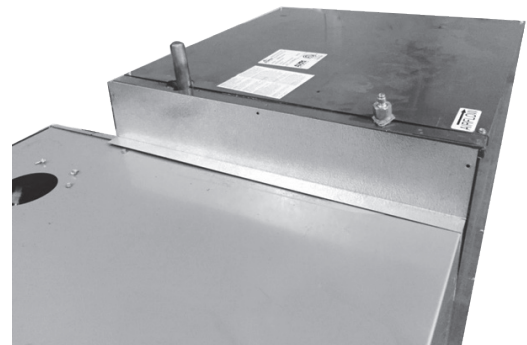

**Note:** Make sure to seal all connection joints. Method of sealing should be performed according to local codes.

## 12. Coil Cleaning Instructions

Aspen horizontal cased coil are equipped with three piece access panel. To access the coil for cleaning and maintenance use the middle access panel. See figure 12-A and 12-B on how to properly remove and install the middle access panel.

For both copper and aluminum tube coils, it is recommended to flush with the coil with water. There are coil cleaners that are available that contain corrosive chemicals, such as, but not limited to, chlorine and hydroxide, that are not approved for use on Aspen copper and aluminum tube coils.

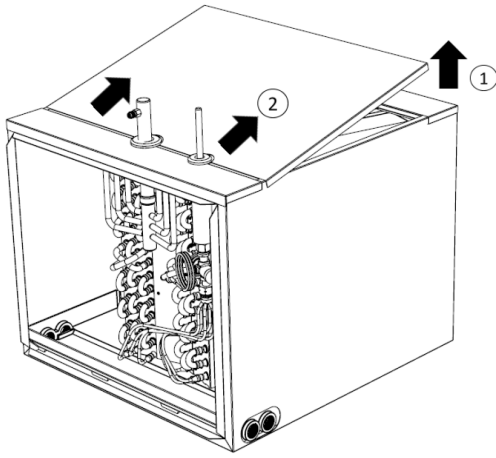

FIG12-A

**FIG12-A:** After removing the screws lift the panel up (1) and slide the panel away from the front panel (2)

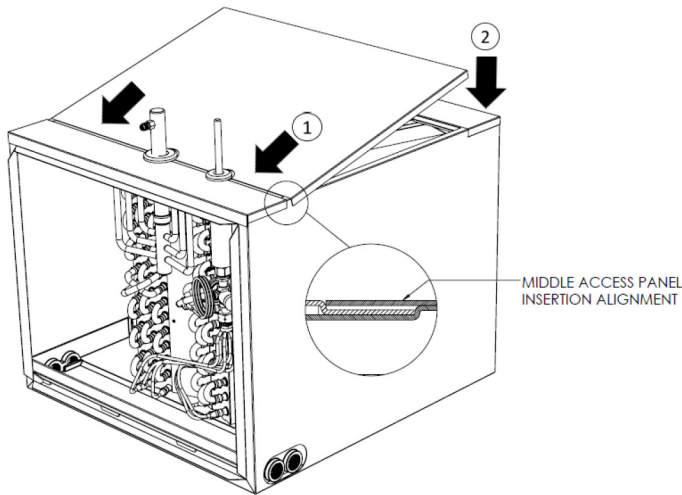

FIG12-B

**FIG12-B:** Slide down and insert the middle panel alignment pocket towards the front panel to lock in place (1), bring down the other side and align it with the back panel and re-install the screws (2).



373 Atascocita Rd.  
Humble, TX 77396  
Phone: 281.441.6500  
Toll Free: 800.423.9007  
Fax: 281.441.6510  
[www.aspenmfg.com](http://www.aspenmfg.com)



Revised 06/14/2022. Subject to change without notice and without incurring obligation.

© Copyright 2022 Aspen Manufacturing. All Rights Reserved